



# **SHIRE** CANAL ENGINE MANUAL



For the following engine models\*:

Shire 60  
Shire 60T  
Shire 65  
Shire 65T

**(Corresponding to the condensed paper copy Manual – RDG603A31)**





\*Standard Model, there may be a number of optional extras, or alternative components, that might be fitted to an engine that are not shown in this book.

## SAFETY

E.P. Barrus is concerned for your safety. We use safety statements throughout the manual to call your attention to the potential hazards associated with the operation of your Shire engine.

Follow the precautions listed throughout the manual before operation, during operation and during servicing/maintenance procedures for your safety, the safety of others and to protect the performance of your engine.

Safety alert symbol appears throughout the manual. It means attention, be alert as your safety is involved. Please read and follow the message that appears after the safety alert symbol.

 <b>NOTICE:</b>	This indicates a situation which can cause damage to the machine, personal property and/or the environment or cause the equipment to operate improperly
 <b>CAUTION:</b>	This indicates a hazardous situation which, if not avoided, could result in minor or moderate injury.
 <b>WARNING:</b>	This indicates a hazardous situation which, if not avoided, could result in death or serious injury.
 <b>DANGER:</b>	This indicates a hazardous situation which, if not avoided, will result in death or serious injury.

## Engine Details

Engine Serial Number:

Please enter your engine serial number in the space provided above. Please quote the engine identification number during any enquiry or when ordering spare parts. Information about the engine serial number and its location on the engine can be found in **SECTION 2** of the manual.

### Shire Engine Manuals and Shire Parts Books

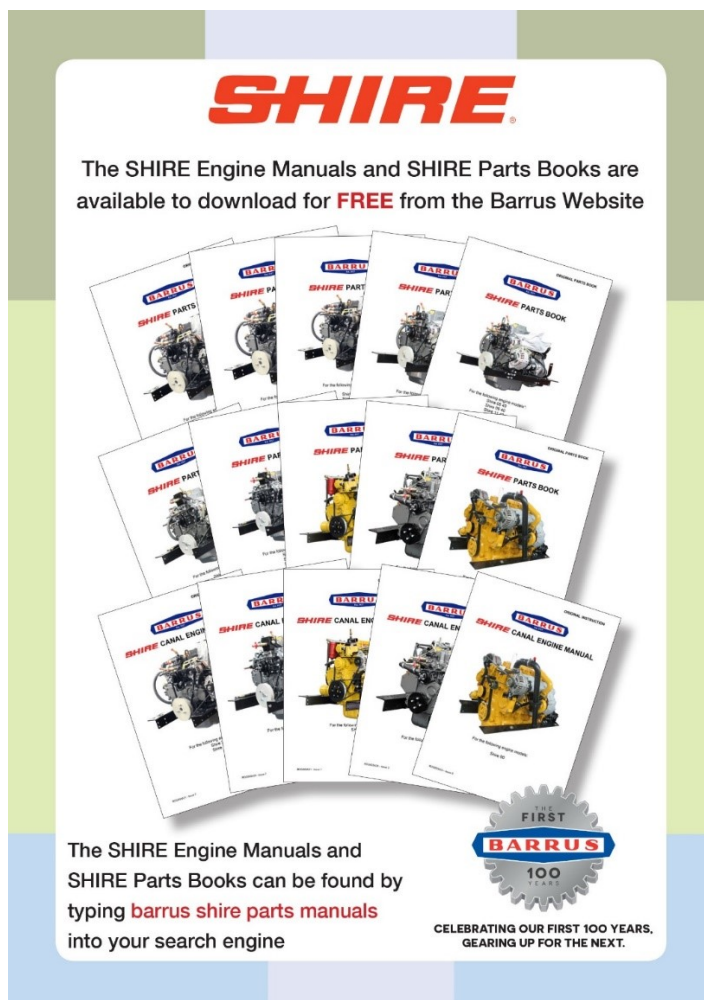

To access the complete Shire Engine Manuals and Shire Parts Books on the internet type the following short links into your search engine or just scan the QR code above.

<https://shireshop.co.uk/> - Shire Shop

<https://www.barrus.co.uk/shire-manuals/> - Complete Shire Engine Manuals

<https://www.barrus.co.uk/shire-parts/> - Shire Parts Books

## Operators Manual

**NOTICE:**

THIS MANUAL FORMS AN INTEGRAL PART OF THE ENGINE IT ACCOMPANIES, IF A TRANSFER OF TITLE OCCURS, IT MUST ALWAYS BE HANDED OVER TO THE NEW OWNER.

Thank you for purchasing this Shire Canal Boat Marine Engine from E.P.Barrus. This manual has been compiled to help you to operate your engine and its associated parts with safety and pleasure. Please read it carefully in conjunction with the PRM Gearbox Manual and familiarise yourself with the engine and its parts before operation. The PRM Gearbox Manual is also available from the PRM website:

[www.prm-newage.com](http://www.prm-newage.com)

If the engine is fitted with an E-Kit and/or Hybrid options, please also read the supplied manuals for them carefully.

The information and recommendations given in this manual are based on the latest information available at the time of publication. E.P.Barrus reserve the right to change the specification of its products and manuals without prior notice.

Depending upon the equipment specification of the engine and accessories fitted, there may be discrepancies with the information presented in this handbook. No claims may be pursued in this respect.

## WARRANTY

The Shire UK Limited Warranty provides coverage for up to five years or 2000 hours (whichever occurs first) for recreational users and three years or 2000 hours (whichever occurs first) for commercial users from the date of warranty commencement. This is dependent on the following conditions.

This covers the majority of Shire Engine components with the exception of the items as stated in this document.

To ensure that you have been registered for your warranty, please detach and fill in the form on the back of this manual.

Return it to the address given or email it to [Richard.Cooke@barrus.co.uk](mailto:Richard.Cooke@barrus.co.uk)

The Warranty will only apply if the following have been carried out and the registration form has been completed and returned to Barrus.

The warranty period begins when either the owner registers the engine or it is triggered automatically. A discretionary period of 6 months is given following the delivery of the engine (to allow for installation and commissioning), following this the warranty period will automatically start.

The repair or replacement of parts, or the performance of service under this warranty, does not extend the life of this warranty beyond its original expiry date.

### TERMS

It is the responsibility of the boat builder or owner to ensure the Shire Engine is registered for warranty.

The Warranty will only apply if the following have been carried out:

- The installation is in full compliance with the requirements defined in the manual and the checklist completed and signed by the engine installer.
- A copy of completed engine installation checklist accompanies the warranty registration form.
- The boat builder or engine installer has completed the Boat Builder Section on the Service Record Card (located at the back of the manual) regarding hand over and commissioning of boat.
- The engine and ancillary systems are installed in compliance with current and applicable national and international standards.
- The maintenance has been completed to the full requirements, using genuine parts and recorded in the manual.

### SAFETY

E.P Barrus staff or their representatives can only carry out warranty repairs if there is suitable and safe access to the boat and engine room.

### PRM GEARBOXES

PRM Gearboxes are covered by a three year warranty for recreation users and two years for commercial users.

## **ELECTRICAL SYSTEMS**

Shire Engine alternator, starter motor and electrical components are subject to a limited one year warranty.

## **FUEL SYSTEMS**

Fuel injection and supply equipment including the injectors and pump(s) are subject to a limited one year warranty.

It is a condition of the warranty that a separate water trap is fitted between the fuel tank and the engine fuel lines (in addition to the filters fitted to the engine). The fuel tank should always be kept clear of dirt, water and any other contamination. It is not recommended that the fuel tank be run completely empty as this will induce air into the fuel system and can cause fuel injection or starting system damage- which would not be covered by the warranty.

Upon installation the fuel system should be pressure or vacuum tested to ensure no leaks are present. Poor quality fuel systems can cause engine fuel injection system damage which is not covered by the warranty. The fuel system should be fully primed ahead of engine starting- failure to do so can cause damage to the engine starting system and fuel system- this damage is not covered by the warranty.

## **POOR QUALITY FUEL**

Poor running (including smoking) engines that are being run (or have been run) on low quality or contaminated fuel are not covered by the warranty. Any replacement parts that are required as a consequence of using incorrect or low quality fuel are not covered by warranty.

Engine and fuel equipment is not covered by warranty if bio-diesel that does not comply with EN15940 is used (See 5. Refuelling of Section 6 – Operation).

Only fuel fully compliant with EN590 or EN15940 should be used in Shire Engines. Failure to comply with this may invalidate the warranty.

## **CONDITIONS THAT MUST BE MET IN ORDER TO OBTAIN WARRANTY COVERAGE**

Warranty coverage is only available from EP Barrus Ltd. Routine maintenance outlined in the Owner's Manual must be performed using genuine parts in order to maintain warranty coverage. If the customer performs maintenance to an insufficient level, Barrus reserves the right to withdraw warranty coverage.

## **WARRANTY CLAIMS**

Warranty claims must be made by either an authorised dealer or directly to EP Barrus.

The dealer or boat builder will arrange for the inspection and any necessary repairs. If the repairs carried out are not covered by the warranty, the purchaser shall pay for all related labour and material, and any other expenses associated with that service.

Any claim should be made as soon as possible, and no later than two weeks after the initial discovery of the defect. No agent outside the EP Barrus Ltd network should be instructed before the defect has been reported and agreement made with EP Barrus Ltd.

## WHAT IS NOT COVERED

This limited warranty does not cover the following:

- Routine maintenance and service items,
- Adjustments,
- Normal wear and tear,
- Damage caused by abnormal or incorrect use,
- Operation of the product in a manner inconsistent with the recommended operation/duty cycle,
- Accident, submersion,
- Improper installation (i.e. an installation not consistent with the requirements laid out),
- Systems using or affected by an accessory or part not manufactured or sold by EP Barrus Ltd,
- Systems that have been altered or modified (including addition of electrical systems such as charge boosters or other electrical management products),
- Expenses related to crane-out, launch, towing, storage, telephone, rental, inconvenience, slip fees, insurance coverage, loan payments, loss of time, loss of income, or any other types of accidental or consequential loss or damages,

Engine and engine starting systems are not covered by warranty if it is found that the engine start battery or supply circuit/system is not of the correct specification. Or if the engine start battery is partially or fully discharged.

Damage due to rust or corrosion, submersion, or unreasonable exposure to the environment, such as exposure to high humidity, rain fall, or seawater, or conditions resulting in the freezing of cooling water are not covered.

Water ingress of any kind into the engine via any means (other than the cooling system) will void the warranty. It is the responsibility of the owner/installer to ensure that no water can enter the engine during use or storage.

The standard alternators fitted to Shire Engines are not suitable for charging lithium-ion batteries. If the standard alternators are used for charging lithium-ion batteries, they will not be covered under warranty. If lithium-ion batteries are to be used a specialist alternator will be required.

## FREQUENT RUNNING

To ensure ongoing and reliable operation, Engines should not be left without running for periods of more than two weeks at any one time. If not required to run, every two weeks the engine should be started and run under load until correct operating temperature is reached- this should then be maintained for a minimum of 15 minutes.

## TRANSFER OF WARRANTY

The warranty is valid for the first owner of the Shire engine and is transferrable only at the discretion of EP Barrus Ltd.

## **DELIVERY**

Damage caused during transport (or before delivery) must be reported to the courier and the delivery signed for highlighting it. Failure to do so may result in the damage not being covered.

Any parts missing from a delivery should be reported to EP Barrus within 3 working days. Photographs of the shipment including packaging will be required.

Note. Engines and ancillary parts are photographed, recorded and stored prior to shipment to the customer.

## **River Canal Rescue Membership**

RCR offer a number of support packages and services to give the inland boater peace of mind in the event of an incident, breakdown or emergency. They offer year round 24/7 national breakdown and recovery assistance for members on the inland waterways.



Please see RCR leaflet included with the other engine documents for more details. The leaflet is stamped and RCR will offer a first year 20% discount to all new Shire engine owners. To gain this discount please call RCR on 01785785680. Please have ready to hand your Shire warranty registration date.

**Note:** This does not affect the normal Shire engine warranty arrangement.



## Index

	Page
<b>SECTION 1 – Safety Precautions .....</b>	<b>13</b>
1. General .....	13
2. Lifting .....	13
3. Rotating Shafts and Belts.....	14
4. Exhaust System .....	14
5. Launching and Lifting Boats .....	15
6. Batteries.....	15
<b>SECTION 2 – Engine Identification.....</b>	<b>16</b>
<b>SECTION 3 – Component Identification.....</b>	<b>17</b>
1. Shire 60 .....	17
2. Shire 65 .....	18
<b>SECTION 4 – Control Panel .....</b>	<b>19</b>
1. Standard Control Panel .....	19
2. Deluxe Control Panel .....	19
3. Control Panel Overview .....	20
4. Warning Light Procedure .....	20
5. Overall Dimensions of the Standard Control Panel .....	22
6. Overall Dimensions of the Deluxe Control Panel.....	22
<b>SECTION 5 – Installation.....</b>	<b>23</b>
1. Ventilation .....	23
2. Engine Beds .....	23
3. Cooling System.....	23
4. Skin Tanks .....	23
5. Engine Cooling Water Inlet and Outlet Hose Connections .....	24
6. Pressurised Water Header Tank .....	25
7. Calorifier .....	26
8. Shaft Connection and Propeller Selection .....	27
9. Engine Anti-Vibration Mounts.....	27

10. Engine Alignment.....	29
11. Engine Inclination.....	30
12. Electrics .....	31
13. Electrical Options .....	32
14. Engine Oil .....	32
15. Fuel.....	32
16. Coolant .....	33
17. Control Cables .....	34
18. Domestic Battery Bank.....	34
19. Control Panel .....	36
20. Exhaust System .....	37
21. Hydraulic Drive Transmissions.....	38
22. Centa Coupling CF-M-160 (RDG2779) .....	38
23. PRM 280DP Gearbox with Power Take Off (Optional Extra).....	39
24. Engine Start Battery .....	39
25. Additional Wiring Connection .....	40
26. Installation Check List .....	41
<b>SECTION 6 – Operation.....</b>	<b>42</b>
1. Starting the engine for the first time.....	42
2. Starting Procedure .....	42
3. Stopping Procedure .....	43
4. Full Load Running.....	43
5. Refuelling.....	43
6. Diesel Fuel Additive .....	44
7. Exhaust Back Pressure.....	44
8. Hybrid System (For engine with Hybrid System fitted) .....	44
9. Single Shift Control Lever Side Mount Operation - Optional (RDG9210055).....	44
<b>SECTION 7 – Service Procedure .....</b>	<b>45</b>
1. Engine Oil and Filter Change .....	45
2. Air Filter Check and Change .....	46

3.	Gearbox Oil Change .....	46
4.	Disposal of Oil and Related Items .....	47
5.	Primary Fuel Filter Drain – Shire 60 & 65 .....	47
6.	Primary and Secondary Fuel Filter Change.....	49
7.	Fuel System Bleeding .....	49
8.	Cooling System.....	51
9.	Belt Adjustment.....	51
10.	Belt Maintenance .....	52
11.	Belt Replacement.....	53
12.	Control Panel Maintenance .....	53
	<b>SECTION 8 – Service Schedule .....</b>	<b>55</b>
1.	Specifications and Capacities .....	55
2.	Service Intervals .....	56
	<b>SECTION 9 – Wiring Diagrams .....</b>	<b>57</b>
1.	Engine Wiring Diagram Shire 60 & 65.....	57
2.	Shire 60 & 65 Cold Start Wiring Diagram .....	58
3.	Standard Control Panel Wiring Diagram .....	59
4.	Deluxe Control Panel Wiring Diagram.....	60
5.	Prestolite 24 Volt 120 Amp Alternator Wiring Diagram .....	61
	<b>SECTION 10 – Technical Data .....</b>	<b>63</b>
1.	Engine Data .....	63
2.	Return Diesel System .....	63
3.	Dry Weight of Engine Data.....	64
4.	Torque Settings for Screws, Bolts and Nuts .....	64
5.	Cylinder Head Tightening Sequence.....	65
6.	Fuel Injection Pump .....	65
	<b>SECTION 11 – Dealer List .....</b>	<b>73</b>
	<b>SECTION 12 – Shire Parts.....</b>	<b>75</b>
	<b>SECTION 13 – Afterlife Recycling .....</b>	<b>77</b>
	<b>SECTION 14 – Declarations .....</b>	<b>78</b>

1. Declaration of Conformity for Recreational Craft Propulsion Engine with the requirements of Directive 2013/53/EU.....	78
2. Declaration of Conformity for Recreational Craft Propulsion Engine with the requirements of the Recreational Craft Regulations 2017 (UKCA Marking). ....	79
3. Declaration of Incorporation of Partly Completed Machinery.....	80
4. EU Declaration of Conformity with the Exhaust Emissions Requirements of Directive 2013/53/EU.....	84
<b>SECTION 15 – Lubricant Safety Data Sheets .....</b>	<b>85</b>
1. Ground Force 10W-40 .....	85
2. Torq-Gard Supreme 15W-40.....	94
<b>SECTION 16 – Shire Service Record Card.....</b>	<b>102</b>

## SECTION 1 – Safety Precautions

### 1. General



**NOTICE:**

NEVER PERMIT ANYONE TO OPERATE THE ENGINE WITHOUT PROPER TRAINING.

It is the responsibility of the installer/operator to ensure that the finished installation complies with CE Marking, UKCA Marking, relevant Health & Safety requirements, the Recreational Craft Directive and or any other legislative requirements before commissioning.

Ensure that the engine battery isolator switch is in the off position and the key removed from the control panel before carrying out any maintenance or repairs.

Ensure that all installations and boat alterations comply with any appropriate local, regional, national or international regulations. When installing new propulsion systems (that are not identical to the original ones) into existing craft, a new vessel Post Construction Assessment will be required, and carried out by an independent notified body.

### 2. Lifting



**DANGER:**

**CRUSH HAZARD!** NEVER STAND UNDER A HOISTED ENGINE. IF THE HOIST MECHANISM FAILS, THE ENGINE WILL FALL ON YOU, CAUSING SERIOUS INJURY OR DEATH.

The Lifting points supplied with the engine are for lifting the engine/gearbox only. A suitable spreader bar must be employed to prevent over-stressing either bracket during any lift.

### 3. Rotating Shafts and Belts



**WARNING:**

**SEVERE HAZARD!** KEEP HANDS AND OTHER BODY PARTS AWAY FROM MOVING/ROTATING PARTS. WEAR TIGHT FITTING CLOTHING AND KEEP YOUR HAIR SHORT OR TIE BACK. REMOVE ALL JEWELLERY BEFORE COMMENCING WORK. CHECK BEFORE STARTING THE ENGINE THAT ANY TOOLS OR RAGS USED DURING MAINTENANCE HAVE BEEN REMOVED FROM THE AREA.

The engine and its accessories are not intended to be put into operation until they are integrated into the boat as a whole. No person should be in the engine compartment and the engine cover or deck hatches should be closed whilst the engine is running.

### 4. Exhaust System



**WARNING:**

**EXHAUST HAZARD!** NEVER OPERATE ENGINE IN A BOATS ENGINE BAY WITHOUT PROPER VENTILATION. NEVER BLOCK VENTS OR OTHER MEANS OF VENTILATION. ALL COMBUSTION ENGINES CREATE CARBON MONOXIDE GAS DURING OPERATION. ACCUMULATION OF THIS GAS COULD CAUSE ILLNESS OR EVEN DEATH.



**WARNING:**

**BURN HAZARD!** WAIT UNTIL THE EXHAUST COOLS BEFORE YOU TOUCH IT.

Exhaust gases may have temperatures as high as 650°C and contain elements which are harmful if ingested.

It is therefore essential that exhaust systems are gas tight and lagged to prevent accidental burning and inhalation of exhaust gases when inside the boat cabin.

## 5. Launching and Lifting Boats

Care must be taken when launching or craning new boats into or out of the waterway, so that water does not enter the engine via the exhaust system or air vents. It is recommended that these are blocked temporarily whilst undertaking this procedure.

## 6. Batteries



**DANGER:**

**EXPLOSION HAZARD!** NEVER SHORT OUT THE BATTERY TERMINALS, INCLUDING WHEN CHECKING THE REMAINING BATTERY CHARGE THIS WILL RESULT IN A SPARK AND MAY CAUSE AN EXPLOSION OR FIRE.



**WARNING:**

**BURN HAZARD!** BATTERIES CONTAIN SULPHURIC ACID. NEVER ALLOW BATTERY FLUID TO COME IN CONTACT WITH SKIN, EYES OR CLOTHING. SEVERE BURNS COULD RESULT. MAKE SURE THE CORRECT PERSONAL PROTECTION EQUIPMENT IS WORN.

- Batteries can produce explosive gases; keep sparks and flames away from the battery.



**NO SMOKING**

- Batteries contain sulphuric acid; if splashed on skin or eyes, flush well with water and seek medical advice.
- Keep battery tops and battery compartment ventilated at all times
- If disconnecting the battery; remove the earth lead **FIRST**; and re-connect it last.
- If charging the battery; ensure that the charger is switched off before connecting and disconnecting.
- Do not tip the battery on its side.
- Please see label on battery or manufacturer's instructions for specific information.

## SECTION 2 – Engine Identification

The engine serial number can be found engraved into the brass plate on the top of the engine rocker cover and stamped to the crankcase next to the starter motor. The Canal Boat Engines (CB) do not have identification initials on the engraved plate.

An example of the engine identification plate is shown below (**Figure 1**):

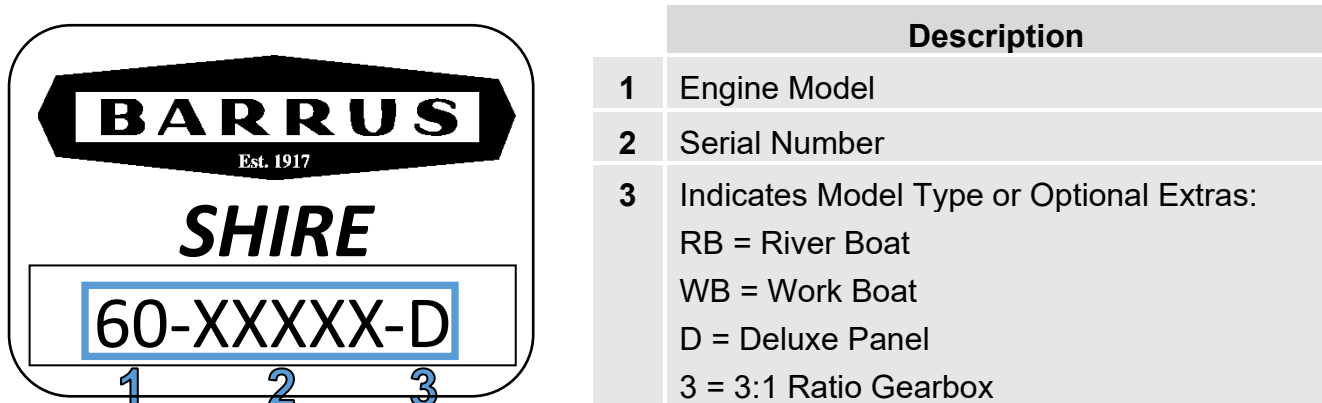

Figure 1: Engine Identification Badge

Description of Models:

Abbreviation	Type of Engine	Description*
CB	Canal Boat	Keel cooled dry exhaust manifold
WB	Work Boat	Seawater/Heat Exchanger cooled, dry exhaust manifold with either a dry exhaust system (same as a Canal Boat) or water injected exhaust system. Can also be used for sea going applications
RB	River Boat	Can also be used for sea going applications. Seawater/Integral exhaust manifold, heat exchanger cooled. Water injected exhaust system.

**\*Note:** There are a number of optional extras that may be fitted to an engine that are not listed here.

A list of common item service part numbers can be found in **Section 12**, Shire Parts.



## SECTION 3 – Component Identification

### 1. Shire 60



Figure 2: Shire 60 Left Side (Viewed from front)

	Description*
1	Single Thermostat Housing
2	40 Amp 12 Volt Alternator
3	150 Amp 12 Volt Alternator
4	Dry Exhaust Outlet



Figure 3: Shire 60 Right Side (Viewed from rear)

	Description*
5	Air Filter
6	Gearbox
7	Oil Filter
8	Primary and Secondary Fuel Filters
9	Engine Sump Pump

**\*Note:** There are a number of other optional extras that may be fitted to an engine that are not shown here.

## 2. Shire 65



Figure 4: Shire 65 Left Side (Viewed from front)

	Description*
1	Single Thermostat Housing
2	50 Amp 12 Volt Alternator
3	150 Amp 12 Volt Alternator
4	Dry Exhaust Outlet



Figure 5: Shire 65 Right Side (Viewed from rear)

	Description*
5	Primary and Secondary Fuel Filters
6	Air Filter
7	Gearbox
8	Oil Filter
9	Engine Sump Pump

**\*Note:** There are a number of other optional extras that may be fitted to an engine that are not shown here.

## SECTION 4 – Control Panel

### 1. Standard Control Panel



Figure 6: Standard Control Panel

	Description
1	Tachometer Gauge
2	Hour Meter
3	Water Temperature Warning Light
4	Oil Pressure Warning Light
5	40A Alternator Charge Warning Light
6	150/240A Alternator Charge Warning Light
7	Glow Plug Light
8	Key Flap and Ignition Switch

### 2. Deluxe Control Panel



Figure 7: Deluxe Control Panel

	Description
1	Tachometer Gauge
2	Hour Meter
3	Water Temperature Warning Light
4	Oil Pressure Warning Light
5	40A Alternator Charge Warning Light
6	150/240A Alternator Charge Warning Light
7	Glow Plug Light
8	Key Flap and Ignition Switch
9	40A Alternator Output Gauge
10	Oil Pressure Gauge
11	Water Temperature Gauge

### 3. Control Panel Overview

- All Shire engines are supplied with a control panel.
- Depending on the model of Shire engine, the control panel will either be a standard control panel or a deluxe control panel. The following table shows which panel comes with each type of engine as standard.

Engine	Control Panel Supplied*
Shire 60, 65	Standard Control Panel

\* Panel supplied as standard. On certain engines a different control panel may be supplied as an option

### 4. Warning Light Procedure

- When the ignition is first turned on, the control panel warning lights will come on as a bulb check. When the engine is started the warning lights will go out. Please note that the water temperature warning light and glow plug light operate slightly differently.
- The water temperature warning light will only come on for a brief period of time when the ignition is first turned on as a bulb check. It will then only illuminate in the case of the engine coolant temperature exceeding the maximum safety level.
- The glow plug light will come on when the ignition is first turned on for 5 – 8 seconds to indicate the heating system is operational. When the light goes out the engine can be started.
- Whilst the control panel is in operation all the gauges are backlit. This does not indicate a fault and is a normal function for the control panel.
- If any of the warning lights on the control panel come on **whilst** the engine is running, please follow the correct procedure as shown in the following table.



**In the event of a fault, only trained and qualified personnel should undertake repairs on the engine**

	Description	Procedure for Warning Light
1	Tachometer Gauge	-
2	Hour Meter	-
3	Water Temperature Warning Light	Reduce the engine revs and stop the engine within one or two minutes. Check the coolant level (refer to <b>8. Cooling System of SECTION 7 - SERVICE PROCEDURE</b> ). If the coolant level is incorrect, fill it to the correct level (refer to <b>8. Cooling System of SECTION 7 - SERVICE PROCEDURE</b> ) and restart the engine. If the coolant level is correct and the fault is still present, or there is a coolant leak, please contact your local dealer.
4	Oil Pressure Warning Light	Stop the engine immediately. Contact your local dealer. Failure to stop the engine may result in permanent engine damage.
5	40A Alternator Charge Warning Light	This indicates that the alternator has stopped charging. The engine can still be operated for a short period of time. Contact your local dealer.
6	150/240A Alternator Charge Warning Light*	This indicates that the alternator has stopped charging. The engine can still be operated for a short period of time. Contact your local dealer.
7	Glow Plug Light	This indicates that the cold start system is operating. If the light fails to illuminate during the starting procedure contact your local dealer.
8	Key Flap and Ignition Switch	-
9	40A Alternator Output Gauge	-
10	Oil Pressure Gauge	-
11	Water Temperature Gauge	-

\*Only applicable if a second alternator is fitted to the engine

**5. Overall Dimensions of the Standard Control Panel**

(All Dimensions are in mm)

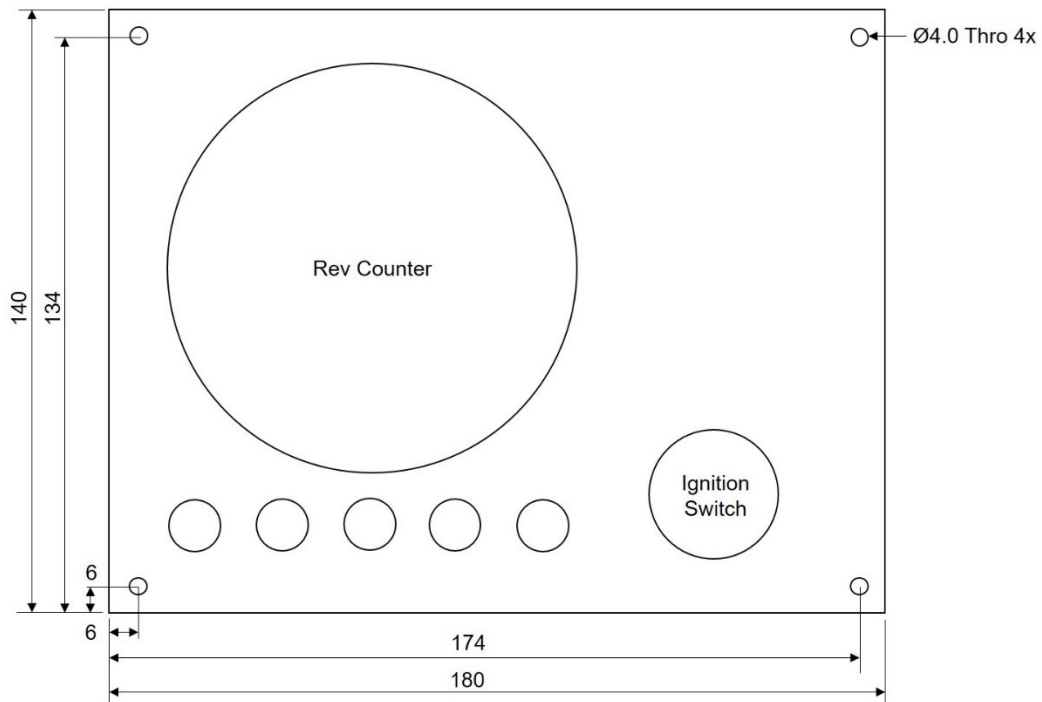

**Figure 8: Standard Control Panel Dimensions**

**6. Overall Dimensions of the Deluxe Control Panel**

(All Dimensions are in mm)

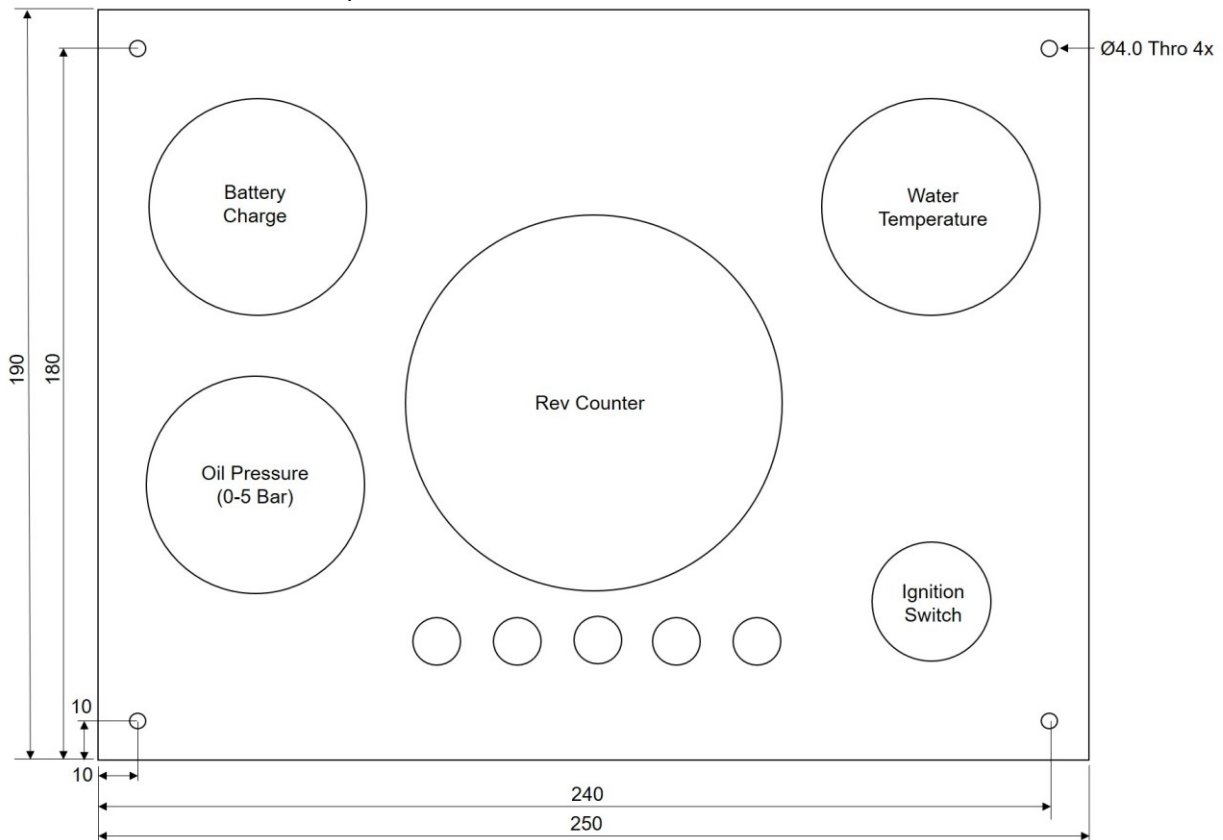

**Figure 9: Deluxe Control Panel Dimensions**

## SECTION 5 – Installation



### NOTICE:

REFER TO THE SHIRE MANUAL PRIOR TO INSTALLING THE ENGINE.

### 1. Ventilation

- All internal combustion engines radiate heat and require cool, clean air to aid complete combustion.
- Please ensure that adequate engine room ventilation is provided, by fitting at least two vents of an aperture of not less than 15,000mm<sup>2</sup> each (24in<sup>2</sup>).



**An allowance must be made for any grills, louvres or bends placed in the airflows and generally an increase of 25% in area is sufficient to overcome any restriction problems.**

### 2. Engine Beds

- These should be a minimum of 10mm thick, extended rearward and be welded to the hull and forward to the bulkhead. Webs or gussets must be welded in place midway to prevent flexing.

### 3. Cooling System

- Ensure pipe work to and from the skin tanks is of sufficient bore. Ensure tight bends and elbows are avoided or kept to a minimum (sizes are listed overleaf).

### 4. Skin Tanks

The ideal skin tank internal thickness is between 50 and 75mm, the table below will indicate a suitable tank size. However, volume will not compensate for lack of surface area. It should be recognised that fitting a large calorifier will increase the theoretical cooling capacity only until it is up to temperature. It is unlikely that a boat on the inland waterways will operate at full power for long periods of time. The engine cooling water outlets are on the right hand (starboard) side of the engine. The outside of the skin tank must be completely below the waterline all of the time for effective cooling.

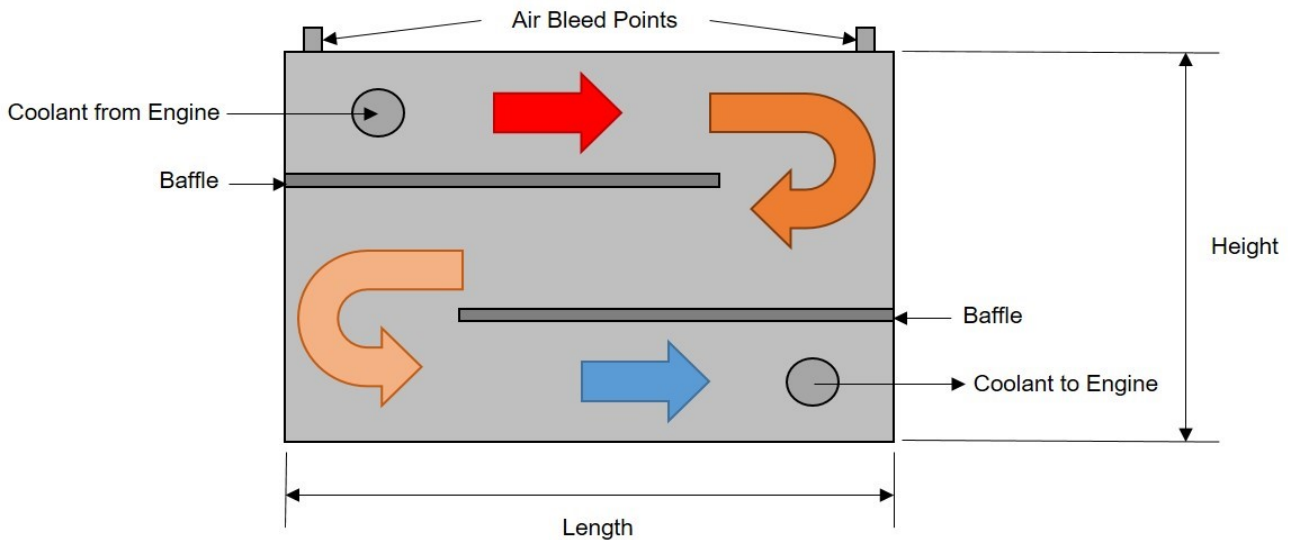

Figure 10: Skin Tank Flow Diagram

Recommended Skin Tank Size					
Engine	HP	KW	Skin tank surface area m <sup>2</sup>	Suggested Height mm	Suggested Length mm
60	60	44	1.35	750	1800
65	65	48	1.46	750	1950



If a hydraulic bow thruster is used, the skin tank size must be increased by up to approx 10% or a separate skin tank installed to cool the hydraulic oil. Please refer to Section 5 – Installation, 21. Hydraulic Drive Transmission for further information.

### 5. Engine Cooling Water Inlet and Outlet Hose Connections

These are on the left hand (port) side of the engine:

Engine	Size (mm)
Shire 60, 65	35mm OD, inlet and 35mm OD, Outlet

Use a good quality hose that cannot collapse or kink and is capable of working at temperature in excess of 100°C.

A.S.A.P. Supplies LTD can supply suitable 35mm ID hoses if the correct size hoses cannot be sourced locally. The part numbers used by A.S.A.P. Supplies LTD are shown in the following table.



A.S.A.P Supplies Part Number	Size of Hose (mm)
206435	35mm

A.S.A.P. Supplies LTD can be contacted by:

Telephone	+44 1502 716993
Internet	www.asap-supplies.com

Please be aware that other suppliers are available.

## 6. Pressurised Water Header Tank



### WARNING:

**SCALD HAZARD!** NEVER REMOVE THE HEADER TANK CAP IF THE ENGINE IS HOT. STEAM AND HOT COOLANT MAY SPURT OUT AND CAUSE INJURY. TIGHTEN THE HEADER TANK CAP SECURELY AFTER BEING REMOVED. STEAM CAN SPURT OUT DURING ENGINE OPERATION IF THE CAP IS LOOSE.

- The pressurised header tank should be mounted higher than the level of the engine, no less than 300mm, and no more than 1m from the engine, to prevent cooling system air locks.
- Shire 60 & 65: Two hoses are used on these engines. One is fitted between the smaller internal diameter (3mm) outlet (on the left hand side of the tank) and the connection on the top of the thermostat housing. The second hose is connected between the larger internal diameter outlet on the right hand side of the tank and the ½" hoesetail connection on the engine pipe facing forwards and upwards at 45°. The hoses **MUST** be connected correctly
- The connections for the Header Tank are shown on (**Figure 11**)
- A constant rise on pipework is required to prevent air locks

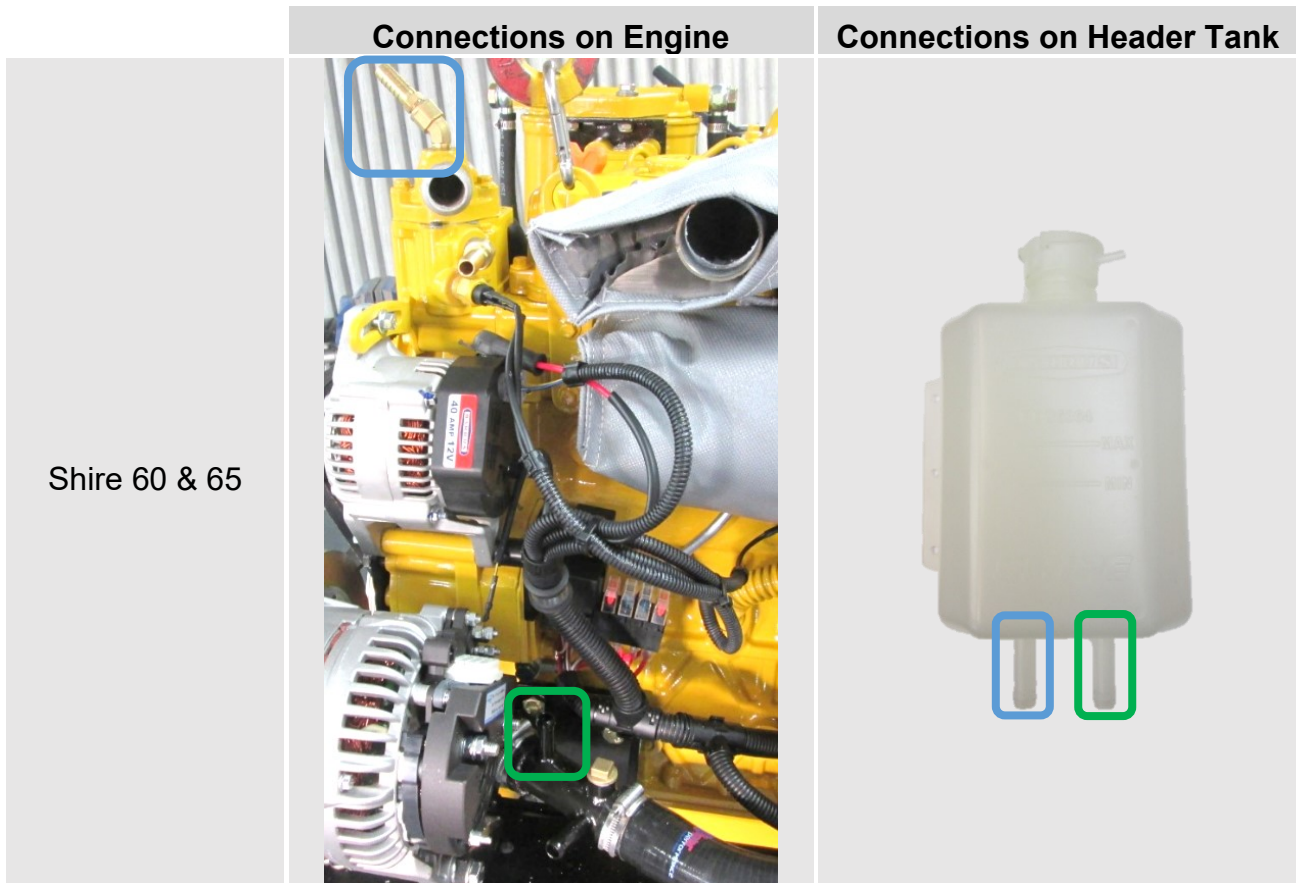

Figure 11: Header Tank Connections

### 7. Calorifier

- The temperature of coolant flowing to the calorifier from the engine can be between 85 and 90°C. A blender valve must be incorporated in the calorifier / hot water system outlet to lower the hot water temperature for domestic use.
- The hose connections for the calorifier are for a ½" internal diameter hose.
- The connections for the calorifier are shown on (**Figure 12**)

**Calorifier Connections on Engine**

Shire 60, 65

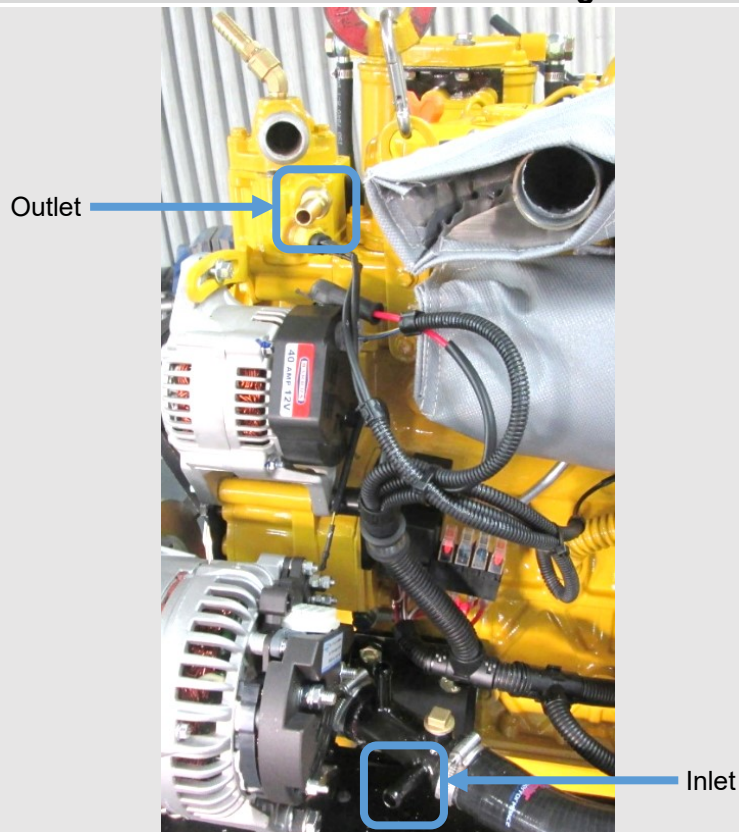

**Figure 12: Calorifier Connections**

**8. Shaft Connection and Propeller Selection**

- Some type of flexible coupling must be used to connect the gearbox output flange to the propeller shaft flange.
- Please note, underperforming engines will not be covered under warranty if the cause of the poor performance is found to be the use of an inappropriate propeller.

**9. Engine Anti-Vibration Mounts**

- Ensure that the engine feet do not end up at the top of the thread on the engine mounts, this puts undue pressure on them and can result in excessive engine movement and premature mount failure. If this is a problem put steel packing plates under the mounts. Packing plates 25mm thick are available: Order RDG3906 Engine mount spacer. Alternatively they can be manufactured locally.
- Ensure that the engine has been installed for at least 24 hours before shaft alignment is checked, to allow the mounts time to settle under the engine weight.
- Ensure that the anti-vibration mount centre screw is sufficiently raised so as not to touch the engine bed. If this occurs, excessive engine vibration will be experienced through the hull.
- For best results, fit the front AV mounts into the front holes in the engine rails. If the engine room space is a problem the mounts can be fitted slightly further back in the

alternative holes and the front of the rail cut off – leaving 50mm of material to retain strength (measuring from the centre of the mount hole to the front end of the rail). Note: This procedure is only possible on non- 'E' kit system engines and may result in a very slight increase in vibration. AV mount installation points are shown on (**Figure 15**)

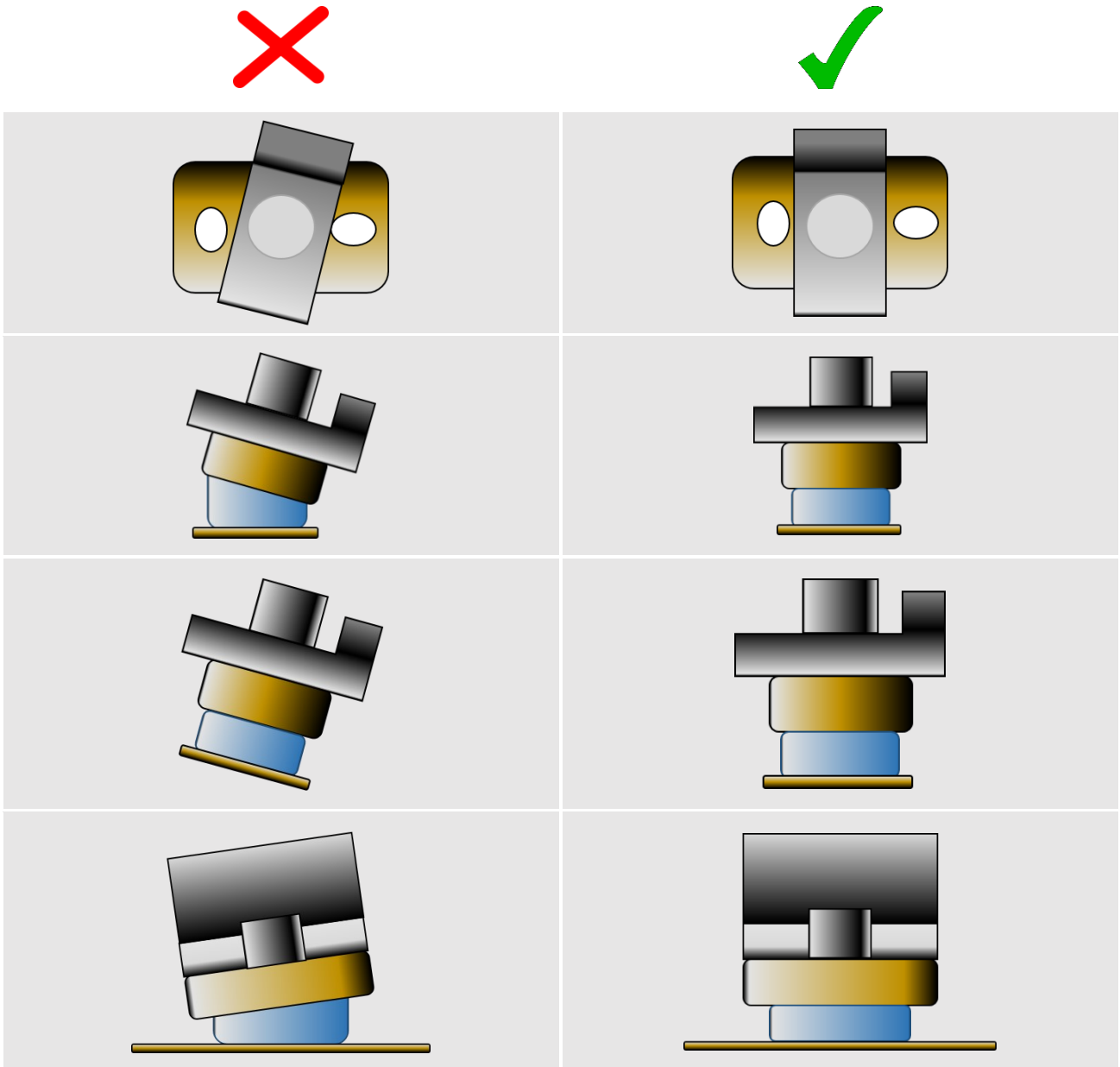

**Figure 13: Correct Anti-Vibration Mount Installation**

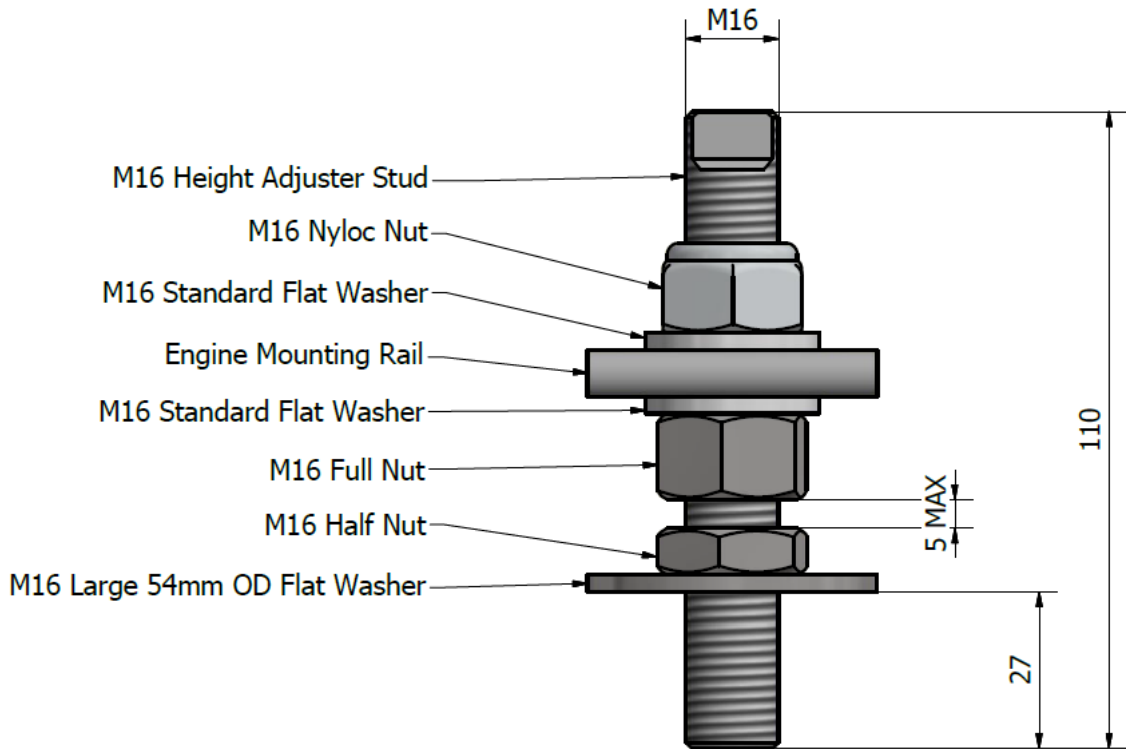

**Figure 14: Correct Anti-Vibration Mount Installation**

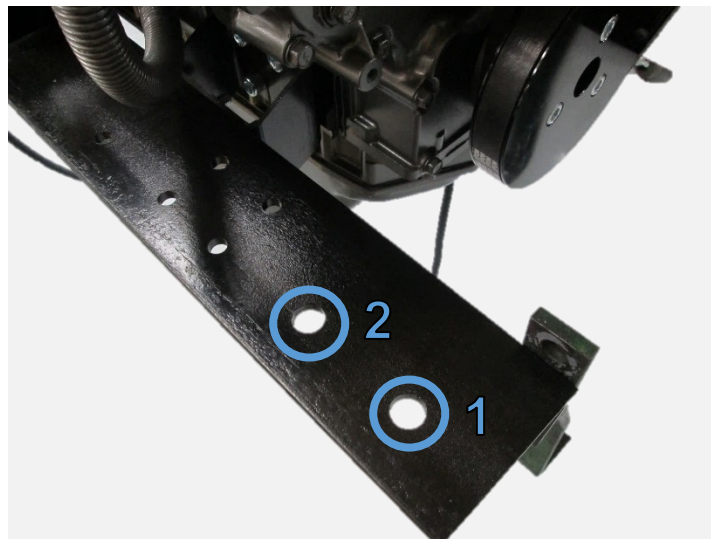

Description	
1	Normal mounting position
2	Alternative mounting position if engine compartment space is restricted

**Figure 15: Anti-Vibration Mount Installation Points**

### 10. Engine Alignment

- The gearbox output shaft flange and propeller shaft input flange must be almost

perfectly aligned. A maximum of 0.05mm (0.002") misalignment in any plane is acceptable. Ensure alignment is recheck after the first 4 hours of running, after the first month and thereafter annually.

- If the engine is out of alignment it will result in excessive vibration and possible damage to the stern tube and propeller shaft.
- Boats that are fitted with fully flexible drive couplings should still have the engine and shaft alignment as close as possible. A dummy shaft may be required for this purpose.



**Some types of flexible shaft couplings require the input and output to be misaligned, check with the coupling manufacturer's installation instructions.**

- Minimum clearance of 25mm between rails and engine beds.

### 11. Engine Inclination

- The engine installation angle is the angle of the crankshaft centre to the water line (**Figure 16**).
- The propulsion efficiency decreases as the engine installation angle increases.
- The **maximum** engine installation angle is 15°

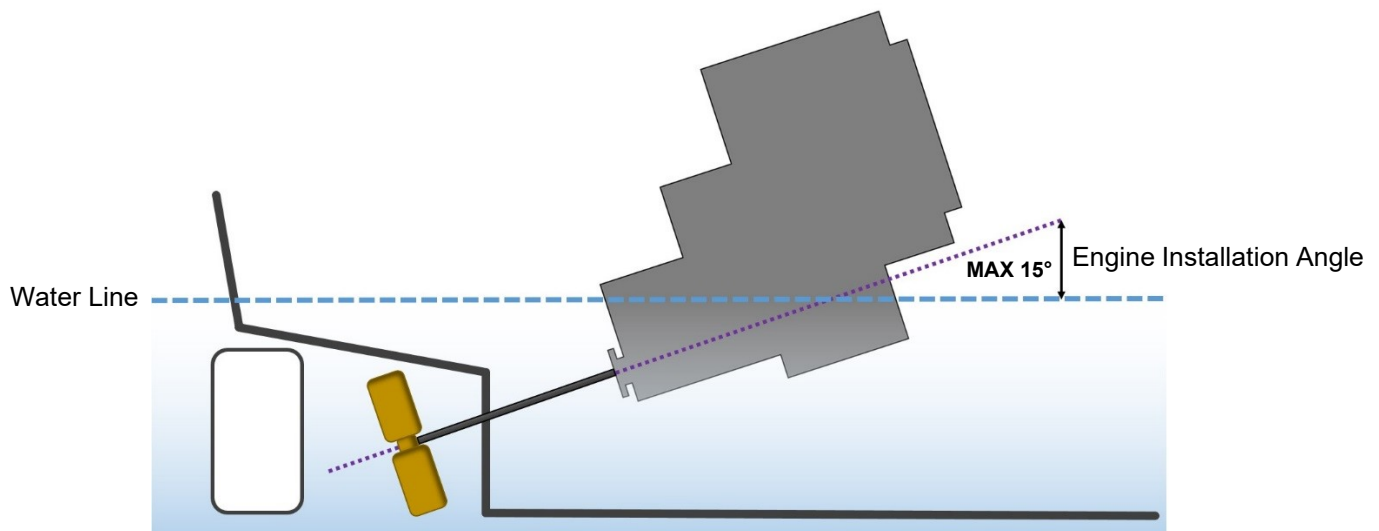

**Figure 16: Maximum Engine Installation Angle**

## 12. Electrics



- Do not attach any part, hose or cable to the engine wiring harness. There is a warning label attached to the harness to remind you of this.
- Connect the wiring extension harness multi plug to the panel plug and the other end to the engine.
- Connect the start battery positive cable to the separate terminal post marked +.
- The starter motor battery cable must have a cross sectional area of at least 50mm<sup>2</sup>.
- For twin alternator engines, connect the domestic battery positive cable to the 150A or 240A Alternator. The 150A alternator has a B+ terminal and the 240A alternator has a “pos out” terminal (see wiring diagram). This ensures that the 40A alternator charges the start battery and the 150A or 240A alternator charges the domestic battery. This removes the requirement for a split charging system or relay.
- The engine is supplied with the domestic alternator belt not fitted. This is so that domestic alternator damage does not occur if the engine is run without the domestic battery back connected. The belt should only be fitted when the domestic battery bank has been connected to the domestic alternator. Belt fitting and tensioning instructions are in **Section 7 – Service Procedure**. Make sure the alignment is correct.
- A cable will need to be manufactured locally and fitted between the lower 150A or 240A alternator and domestic battery positive terminal. The cable should have a minimum cross sectional area of:

	Cross Sectional Area
Shire 60, 65	40mm <sup>2</sup> (150A Alternator)
Shire 60, 65 (Option)	70mm <sup>2</sup> (240A Alternator)
24v 120amp Alternator	40mm <sup>2</sup>

- Both negative battery terminals can be connected to a common earth point.

Note: The 240A alternator is of the insulated earth design and requires a heavy-duty earth cable installed at all times.

Note: If an optional larger output alternator is fitted to either a new engine, or fitted to an old engine as an upgrade, ensure that all cables, master switches, terminals, split charge relays etc. are of sufficient capacity for the increased current.

### 13. Electrical Options



- If the engine is fitted with the optional 230V 'E' Kit System, refer to the manual supplied with it for correct wiring, control box installation and operation.
- The Shire range can be supplied with other optional additional 12V, 24V or 48V alternators. This will be supplied fitted but not wired. It is the responsibility of the boat builder to ensure that this is correctly wired to the boats electrical system.

### 14. Engine Oil



**BURN HAZARD!** WAIT UNTIL THE ENGINE COOLS BEFORE YOU DRAIN THE ENGINE OIL. HOT ENGINE OIL MAY SPLASH AND BURN YOU.



**NOTICE:**

ENGINE OIL WITH A HIGHER API CLASS THAN CD IS UNSUITABLE FOR CANAL BOAT OPERATION AND WILL CAUSE ENGINE DAMAGE IF USED.

- All Shire engines are supplied fully run in.
- Check oil levels in engine and gearbox before starting
- Use good quality engine oil SAE 15W / 40 API class CD

### 15. Fuel



DIESEL FUEL IS FLAMMABLE AND EXPLOSIVE UNDER CERTAIN CONDITIONS.





**WARNING:**

DIESEL FUEL IS HARMFUL TO SKIN. MAKE SURE THE RELEVANT PERSONAL PROTECTION EQUIPMENT IS WORN.

- Ensure the main fuel tank is clear of dirt and water.
- A separate water trap must be fitted to all engine installations. The Shire 60 & 65 engines are supplied with an additional fuel pre-filter water trap as standard.
- Connect fuel feed return hoses from engine to main supply and return lines to main fuel tank, ensuring they are connected the correct way around. The hose to the electric fuel pump is the inlet.
- The engine hoses are supplied with 8mm (5/16") OD metal hometails and should be securely fitted to the main supply and return pipes with compression fittings.
- The engine hoses should have sufficient slack to absorb engine movement without placing strain on the hoses and be securely clipped to prevent accidental damage and chafing.
- Initially fill the fuel system by turning the ignition on to operate the electric fuel pump. Loosen the bleed screw on the top of the primary fuel filter / water trap and close when fuel begins to flow clearly (no bubbles). The rest of the process is done automatically by the engine. It is rarely necessary to bleed the injection pump or injectors upon installation as the engine will already have fuel in it from the engine run in and test procedure.

## 16. Coolant



**WARNING:**

**SCALD HAZARD!** NEVER REMOVE THE COOLANT BOTTLE CAP IF THE ENGINE IS HOT. STEAM AND HOT COOLANT WILL SPURT OUT AND CAUSE INJURY. TIGHTEN THE CAP SECURELY AFTER BEING REMOVED. STEAM MAY SPURT OUT DURING ENGINE OPERATION IF THE CAP IS LOOSE.



**WARNING:**

**BURN HAZARD!** WAIT UNTIL THE ENGINE COOLS BEFORE YOU DRAIN THE ENGINE COOLANT. HOT ENGINE COOLANT MAY SPLASH AND BURN YOU.



**WARNING:**

**BURN HAZARD!** THE WATER COOLED EXHAUST MANIFOLD IS HOT AND MAY BURN YOU.

- Prepare coolant mix of 50% clean tap water and 50% antifreeze.
- Open the calorifier taps (if fitted) to fill the calorifier system and displace air.
- To fill the cooling system for the first time, fill the boat skin via the inlet hose connection or filler plug if fitted.
- Shire 60 & 65: Fill the engine through the white plastic expansion tank.



**After running the engine for the first time, stop the engine and monitor the water level frequently as trapped air bubbles may be expelled. Top up the system as necessary.**

### 17. Control Cables

- Connect engine speed control cable. With the engine off, ensure that the engine speed control lever achieves full travel from idle to full speed. Adjust if necessary.
- Check the gearbox shift lever selects positively and that the drive direction corresponds with the gearshift control lever. Ensure that the gearbox control lever and the gearshift lever are both in neutral before connection. Adjust if necessary.

### 18. Domestic Battery Bank



**DANGER:**

**EXPLOSION HAZARD!** NEVER SHORT OUT THE BATTERY TERMINALS, INCLUDING WHEN CHECKING THE REMAINING BATTERY CHARGE THIS WILL RESULT IN A SPARK AND MAY CAUSE AN EXPLOSION OR FIRE.

**WARNING:**

**BURN HAZARD!** BATTERIES CONTAIN SULPHURIC ACID. NEVER ALLOW BATTERY FLUID TO COME IN CONTACT WITH SKIN, EYES OR CLOTHING. SEVERE BURNS COULD RESULT. MAKE SURE THE CORRECT PERSONAL PROTECTION EQUIPMENT IS WORN.

Domestic battery banks that are too large create excessive loads on the domestic alternator. Alternators running at maximum output for prolonged periods of time will eventually fail prematurely; alternators that fail due to the battery bank being over the maximum recommended size will not be covered by warranty.

Higher output additional alternators, or 'E' kits are available: if larger battery banks are required discuss your individual power requirements with the boat builder or engine supplier.

- The maximum domestic battery bank is calculated using the following:
  - Live aboard, three times domestic alternator, maximum output current.
  - Weekend cruising or hire fleet use, three and a half times domestic alternator, maximum output current.

**Example 1:**

Live aboard application fitted with a 150amp domestic alternator

$3 \times 150 = 450$  ampere/hour maximum battery bank size

**Example 2:**

Weekend cruising or hire fleet application fitted with a 240amp domestic alternator

$3.5 \times 240 = 840$  ampere/hour maximum battery bank size.



**The standard alternators fitted to Shire engines are not suitable for charging lithium-ion batteries. If the standard alternators are used for charging lithium-ion batteries, they will not be covered under warranty. If lithium-ion batteries are to be used a specialist alternator will be required.**

## 19. Control Panel

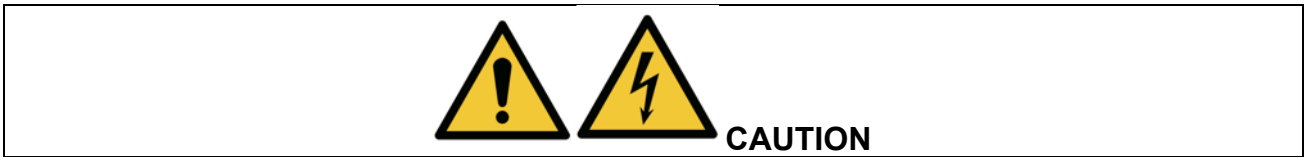

All Shire engines are supplied with an engine control panel that shows RPM and hours run and include warning lights and a warning buzzer. The deluxe panels also have additional gauges for the water temp, oil pressure and battery charging. The panels are designed to be splash proof and are correctly installed with the gauges vertical. Do not install so that they remain out in the open, or cover up when not on use.

The control panel engine tachometer is supplied already calibrated to measure correct engine speed. If a new control panel, tachometer or alternative alternator is fitted, the tacho will require re-calibrating.

### Control Panel Calibration Procedure:

- Connect control panel plug to engine wiring loom plug.
- Turn ignition on (do not start engine).
- Press and hold black button on rear of tacho until “H-“appears on the digital display at the bottom of the tacho (on the front).
- When pressing and holding the black button on rear of tacho, the value displayed will increase / decrease until the button is released. Then when pressing again it will increase / decrease in the other direction. Keep doing this until the digitally displayed value on the bottom of tacho reaches the correct value, according to the type of alternator (see below table). This must be set to the alternator with blue and black wire connected to it.
- Confirm settings to tacho meter reader.
- An optical tachometer is required to check the reading.

Barrus Alternator (Amps)	Barrus Tacho reading
40	10.50 – 11.00
150	19.50 – 20.00
240	22.00

Alternative or non-standard alternators will require calibrating and checking by trial and error, with a hand held tacho until the engine speed and indicated tachometer speed are the same. Engine energise to stop systems are available as an optional extra.

## 20. Exhaust System



**WARNING:**

**EXHAUST HAZARD!** NEVER OPERATE ENGINE WITHOUT PROPER VENTILATION. NEVER BLOCK VENTS OR OTHER MEANS OF VENTILATION. ALL COMBUSTION ENGINES CREATE CARBON MONOXIDE GAS DURING OPERATION. ACCUMULATION OF THIS GAS COULD CAUSE ILLNESS OR EVEN DEATH.

The exhaust outlet size on the engine is 1½” BSP female. There must be a flexible exhaust hose of suitable exhaust grade between the engine and the silencer or hull outlet. The outlet must be above the waterline at all times. The exhaust fittings and silencer (if fitted), must not be smaller than 1½” BSP. Exhaust silencers, flexible exhaust hose connections and lagging blanket are all available as optional extras:

Part Description	Part Number
Exhaust Coupling 1½” x 1½” BSP	RDG1916
Exhaust Silencer DSA-38	RDG1911
Flexible Exhaust Hose (18”)	RDG1879
Blanket 18” Flexy Exhaust	RDG2477
Hospital Silencer 1½” BSP	RDG6536
1 ½”F x 1 ½”F BSP 90 Elbow	RDG5898

Make sure the exhaust increases then decreases in height as shown in (Figure 17).

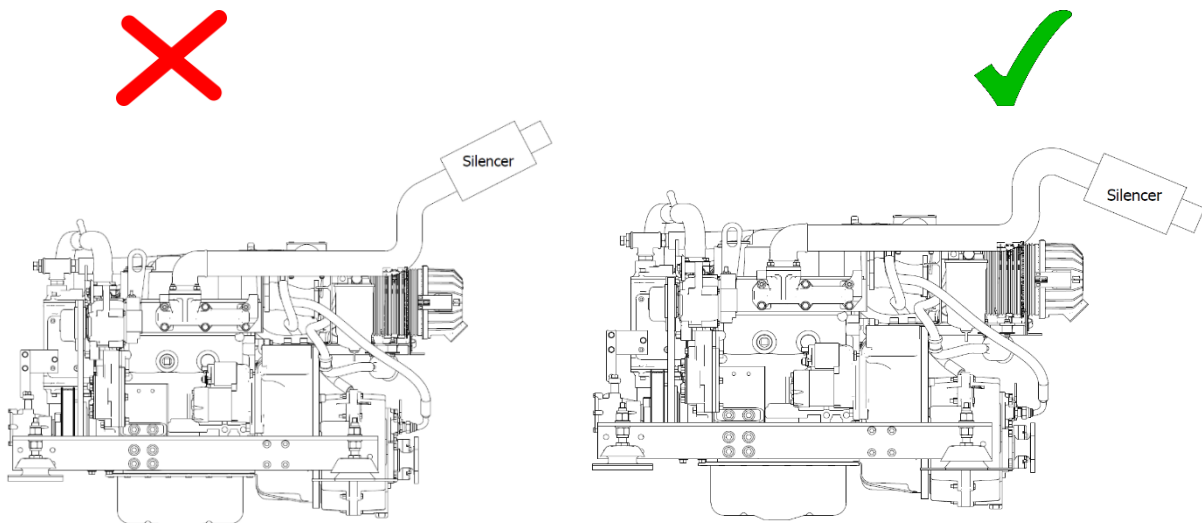

**Figure 17: Correct Exhaust Installation**

## 21. Hydraulic Drive Transmissions

If an engine is to have a hydraulic drive transmission attached to it instead of a conventional marine gearbox, a number of points must be observed.

- Bobtail engines (i.e. Engines supplied without a marine gearbox), normally do not have a gearbox oil cooler fitted. However if a cooler is supplied, this will only be suitable to cool a conventional marine gearbox.
- Hydraulic drive transmissions generate far more heat than a conventional marine gearbox. Therefore the size of the oil cooler installed must be calculated by the hydraulic drive transmission supplier. This is to ensure it has sufficient cooling capacity and is sized appropriately taking into account:
  - Maximum engine power.
  - High ambient summer air temperature.
  - Summer River/Canal/Sea temperature.
  - No additional restriction to engine coolant flow is present.

Skin tanks will also need to be increased by up to approx. 10% to dissipate the additional heat generated, when a hydraulic drive system or hydraulic bow thruster is used.

Or

An additional separate skin tank of suitable capacity with separate water circulating pump may need to be fitted for a hydraulic drive transmission.



**Hydraulic oil coolers should be installed after the engine, not before. Coolers that are installed before the engine will invalidate the engine warranty.**

## 22. Centa Coupling CF-M-160 (RDG2779)

Centa have given Barrus permission to use the following instruction on how to fit the coupling: When assembling the coupling all the bolts and nuts must be tightened to the correct torque using a torque wrench. Tightening by “feel” will not give a satisfactory result.

- Remove the clamping bush from the coupling.
- Degrease the propeller shaft and the bore of the clamping hub. Leave the special grease only in the tapered bore of the coupling hub, and on the outside of the clamping hub. **DO NOT USE SOLVENTS.**
- Mount the coupling onto the gearbox output flange. Note: The M10 tapped holes in the coupling are 15/17mm, so care must be taken to use screws or studs of the correct

length. Centa recommend the use of M10 x 25 screws or M10 x 40 studs. If using studs the shorter (10mm) screwed portion should be inserted into the coupling.

**TIGHTENING TORQUE IS 45Nm**

- Push the clamping hub fully onto propeller shaft.
- Connect the clamping hub/propeller shaft onto the coupling. The connecting screws of the clamping bush must be tightened alternately in several steps until the required tightening torque is reached. Finally, the tightening torque of all fasteners must be checked all round. **TIGHTENING TORQUE (M12x40) is 79Nm**



**The tightening of the connecting screws between the clamping bush and the hub means that the clamping hub/propeller shaft will be dragged into the coupling by a few millimetre's, thereby effectively shortening the installation length. Sufficient free space (minimum 10mm) should be available between the outer bearing and the propeller hub.**

The propeller-thrust (or propeller-pull in reverse drive) is safely transmitted via the coupling from the propeller shaft to the gearbox, but the design of the coupling is such that the rubber must be compressed when sailing in the forward direction. The coupling is not suitable for use with vee-drive gearboxes having outputs of the quill-shaft arrangement where the coupling would be subject to a pulling force when sailing forward.

The coupling uses a bonded rubber element, and care should be taken not to contaminate the rubber by indiscriminate use of solvents or anaerobic liquids.

### **23. PRM 280DP Gearbox with Power Take Off (Optional Extra)**

The PRM 280 with power take off is designed for driving hydraulic pumps made to SAEJ77 Series B specification. The maximum power which can be transmitted is 22kW (29.5hp) per 1000rpm.



**The power take off operates in the opposite direction to the gearbox input shaft. The output of the live power take off is the same speed as the engine.**

### **24. Engine Start Battery**

For the required specification of the Engine Start Battery, please refer to **Section 10 – Technical Data.**

## **25. Additional Wiring Connection**

An additional grey wire tag is fitted which is found coming out of the loom near the relay. This is live only when the ignition is energised and can be used to trigger a circuit that may be required to operate only when the engine is running such as a bow thruster, calorifier / heating system circulation pump, engine cover microswitch operated magnet, etc. This wire is labelled on the wiring loom diagram as "Not Connected".

Note, this wire should only be used to operate an electrical relay in conjunction with a separate fused supply.



## 26. Installation Check List

Please tick box ✓	
Engine alignment correct, clearance all round, check propeller turns by hand (Ensure ignition is off battery and battery master switch is off)	
Anti-Vibration mounts correct height, spacers if necessary. Make sure all nuts are tight	
Exhaust system as specified	
Check the correct size of start battery has been fitted	
Battery leads are of correct size, tightened and start battery is charged	
Check tension of alternator belts, wiring connected and belt alignment checked if removed	
Check fuel system is connected correctly and primed	
Fuel line water trap installed and water drained off	
Check header tank and skin tank connections are correct way round, constant pipework rise to header tank	
Check level of coolant in header tank and correct ratio of antifreeze to water	
All air has been bled from skin tank, calorifier and pipework	
Engine and gearbox oil levels are as specified	
Throttle and gear cables correctly adjusted and operating smoothly	
All pipework and cabling supported and not chaffing, slack to allow movement of engine	
Engine control panel installed in a position where it is not out in the open	
Confirm engine control panel, gauges and warning lights are all operational	
Run the engine for 20 minutes with the boat tied up and in gear (at ½ speed). Check for leaks and that all systems operate correctly	
Check & Set the Engine Idle Speed to 875 rpm (when warm)	
Check for leaks	
Explain/Demonstrate daily/weekly/periodic maintenance checks	
Explain/Demonstrate off season storage and maintenance	
'E' Kit 230v AC power systems installed by qualified electrician and to BMEA code of practice for Electrical and Electronic installation in Boats: BS EN ISO 13297 (ac)	
Installer's signature	
Installer name/company	

## SECTION 6 – Operation

**NOTICE:**

REFER TO THE SHIRE MANUAL PRIOR TO STARTING THE ENGINE.

### 1. Starting the engine for the first time

- Remove ignition key.
- Ensure all oil and coolant levels are checked.
- Ensure both the engine and domestic batteries are connected. Both battery master switches must be turned on. Failure to do so may damage the domestic alternator.

### 2. Starting Procedure

- Ensure there is no one in the engine compartment.
- Ensure the engine compartment door is closed.
- Ensure the gearshift control level is set to neutral and that all persons are clear of any moving parts.
- Insert ignition key.
- Turn key to on position. The glow plug light will illuminate.
- Observe warning lights (and gauges on deluxe panel). Note: The engine water temperature overheat warning light will only come on for a brief period of time when the ignition is first turned on as a bulb check. It will then only illuminate in the case of the engine coolant temperature exceeding the maximum safety level.
- Wait for the glow plug light to go out.
- Turn key to start and hold to crank.
- Crank the engine for no more than 15 seconds.
- Upon engine start, immediately release the key.
- Key will return to on position.
- The warning buzzer will stop and on the deluxe panel, the oil pressure gauge will show an oil pressure of 2.5 - 3.5 bar (36 - 51 psi).
- Should any warning light not go out, or if there is no reading on the oil pressure gauge, the buzzer will continue sounding. In this case, stop the engine immediately and check the relevant system (Note: If the charge light does not go out, briefly increase the engine speed).
- Stop engine if any abnormal noises are detected.
- Visually check the engine for oil, fuel and coolant leaks, after initial start-up and at regular intervals. Note: Engine must be stopped, with ignition key removed, to carry

out this check.

### 3. Stopping Procedure

- Move speed control lever to idle position.
- Turn key to off position.

### 4. Full Load Running

- Running diesel engines near their rated output (maximum load) regularly will disperse accumulated carbon and condensation, enhancing engine life and reducing emissions.
- Running the engine at, or near maximum speed whilst in gear may not be possible on inland waterways with speed limits in place. If this is possible, ensure that the water is deep enough not to damage the propeller. It is recommended that the engine is run at or near full load for 15 minutes (maximum revs, in gear) every 50 hours.

### 5. Refuelling



**WARNING:**

DIESEL FUEL IS FLAMMABLE AND EXPLOSIVE UNDER CERTAIN CONDITIONS.



**WARNING:**

DIESEL FUEL IS HARMFUL TO SKIN. MAKE SURE THE RELEVANT PERSONAL PROTECTION EQUIPMENT IS WORN.

- All Shire canal boat engines run on diesel fuel.
- Please note that when the vessel is to be left for any period of time, the fuel tank should be left full to eliminate the build-up of condensation and formation of water in the fuel tank.
- Engine to be turned off while refuelling
- The fuel type for all Shire canal boat engines is diesel. **DO NOT USE BIODIESEL.**

## **6. Diesel Fuel Additive**

The use of diesel fuel additive is recommended on Shire engines. The quality of the fuel available when cruising is often unknown. Also the fuel may have been in storage for long periods of time. The use of additives will ensure that your engine fuel injection system is in top condition which should result in many years of smooth reliable operation, without the cost and inconvenience of expensive breakdowns due to poor quality fuel. It has also been found that improvements in fuel consumption and start ability are an added benefit of using this product. Diesel fuel additive is available from your Shire dealer in a handy 500ml container, Part Number RDG80210219.

## **7. Exhaust Back Pressure**

The back pressure falls within the manufacturers recommended range when using the optional exhaust system (see **20. Exhaust System** from **Section 5 – Installation**) with the engine.

## **8. Hybrid System (For engine with Hybrid System fitted)**

Refer to the separate Hybrid Operation Manual for more details on the system.

## **9. Single Shift Control Lever Side Mount Operation - Optional (RDG9210055)**

To engage forward or reverse gear:

- Lift the safety latch under the handle before shifting.

To rev the engine in neutral:

- Pull the lever out sideways from the main body.
- Lift the safety latch under the handle then shift.

## SECTION 7 – Service Procedure



**NOTICE:**

REFER TO THE MANUAL PRIOR TO CARRYING OUT ANY SERVICE OR MAINTENANCE WORK.



**WARNING:**

PRIOR TO CARRYING OUT ANY SERVICE OR MAINTENANCE WORK MAKE SURE THE RELEVANT PERSONAL PROTECTION EQUIPMENT IS WORN.

### 1. Engine Oil and Filter Change



**WARNING:**

**BURN HAZARD!** WAIT UNTIL THE ENGINE COOLS SLIGHTLY BEFORE YOU DRAIN THE ENGINE OIL. HOT ENGINE OIL MAY SPLASH AND BURN YOU.

- Change the engine oil while the engine is still warm.
- Remove the blanking plug in the sump pump spout (6mm Allen key).
- Place a plastic tube over the spout and into a container. Operate the pump handle **SLOWLY** (to prevent drawing air into the oil flow when pumping) to empty the sump. Note: Remember to refit the blanking plug afterwards.
- Place a drip tray under the engine to catch the small amount of oil that will escape from the oil filter. Using the strap type oil filter removal tool supplied with the engine, slacken the filter from the engine block in an anti-clockwise direction. Remove the tool and spin off the filter.
- Lightly oil the new filter O ring seal and install the filter onto the engine. Spin it on in a clockwise direction and finally tighten by hand only as firmly as you can.
- Refill the sump using the orange oil filler cap in the rocker cover on top of the engine.
- Oil level should be to the top mark on the dipstick.
- Run the engine for 5 minutes before checking the oil level with the dipstick and top up if required.
- Do not exceed the maximum oil level marker as this may cause damage to the internal

components of the engine.

## 2. Air Filter Check and Change

- Release the two spring clips. Pull off the end cover to reveal the filter element. The element simply pulls out.
- To fit the new element, slide the open end of the filter element into the main body. Gently push the element until fully seated. Refit the end cover.
- The air filter is constructed from pleated paper. Inspect it closely for dust or dirt. The air filter cannot be cleaned and must be replaced when dirty. The engine requires clean unrestricted air to run efficiently. Failure to maintain the air filter could result in smoke, increased fuel consumption and ultimately engine damage.

## 3. Gearbox Oil Change



**WARNING:**

**BURN HAZARD!** WAIT UNTIL THE GEARBOX COOLS SLIGHTLY BEFORE YOU DRAIN THE GEARBOX OIL. HOT OIL MAY SPLASH AND BURN YOU.



**Some engines will have a gearbox sump pump fitted. To change the oil in this circumstance, follow the same procedures as were outlined for changing the engine oil. For engines without a gearbox sump pump follow the procedure below.**

- Change the gearbox oil while it is still warm (Please refer to the gearbox manual for more information).
- Place a tray beneath the gearbox that will hold at least 2 litres.
- Remove the drain plug and allow 5 minutes for the oil to drain thoroughly.
- Replace the drain plug. Ensure that the sealing washer (if used) is still in place and in good condition before tightening. Fit a new washer if required.
- Refill the gearbox with oil to the upper mark on the dipstick. Screw the dipstick in fully, to establish level. Refer to the PRM owner manual for more details. **Section 8** in this Shire manual contains details of oil specifications.
- Do not overfill the gearbox as this can damage the internal components.

Gearbox Model	Location of Dipstick / Filler Plug / Drain Plug
PRM 150	 <p>Level dipstick &amp; Filler Plug</p>
PRM 280	 <p>Level dipstick &amp; Filler Plug</p>

Figure 18: Location of Dipstick / Filler Plug / Drain Plug on Gearbox

#### 4. Disposal of Oil and Related Items

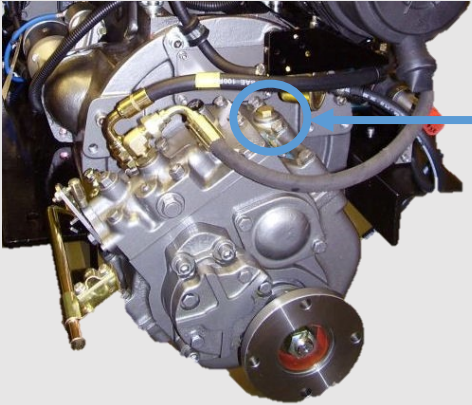

**NOTICE:**

ALWAYS BE ENVIRONMENTALLY RESPONSIBLE.

- Please dispose of used oil and oil filters safely with due regard for the environment and take to your local waste oil disposal point.
- Do not allow oil or contaminated parts to enter the inland water way system.

#### 5. Primary Fuel Filter Drain – Shire 60 & 65



**WARNING:**

DIESEL FUEL IS FLAMMABLE AND EXPLOSIVE UNDER CERTAIN CONDITIONS.

**WARNING:**

DIESEL FUEL IS HARMFUL TO SKIN. MAKE SURE THE RELEVANT PERSONAL PROTECTION EQUIPMENT IS WORN.

- Place a small drain bowl under the primary fuel filter / water trap.
- Loosen the drain screw located in the bottom of the fuel filter / water trap (**Figure 19**)
- Drain off any water.
- Once the water has been drained, retighten the drain screw.
- It is unlikely the complete fuel system will require bleeding.
- Run for 5 minutes.
- Check that the drain union is tight and that there are no leaks.
- Do not over tighten the drain screw.



The boat builder should have fitted an additional water trap in the fuel system. Ensure that this is drained regularly.



**Figure 19: Primary Fuel Filter Drain Screw**



## 6. Primary and Secondary Fuel Filter Change



**DANGER:**

DIESEL FUEL IS FLAMMABLE AND EXPLOSIVE UNDER CERTAIN CONDITIONS.



**WARNING:**

DIESEL FUEL IS HARMFUL TO SKIN. MAKE SURE THE RELEVANT PERSONAL PROTECTION EQUIPMENT IS WORN.

- Ensure the fuel tank is at least  $\frac{3}{4}$  full prior to undertaking this procedure.
- Turn off the main boat fuel supply tap. This is located on or near the fuel tank.
- Place a small drip tray under the filter body.
- Remove the fuel filters using the filter strap wrench supplied. Unscrew them until loose then remove by hand.
- Primary fuel filter only: Retain the metal fuel filter drain screw from the old filter and reuse in the new filter. The part number for the drain screw is RDG9189022.
- Smear a small amount of clean fuel on all of the O ring seals that are supplied with the new filter element.
- Screw the new element back into the filter head. Tighten by hand only.
- Turn the main boat fuel supply tap back on.
- Ensure the system is correctly bled before attempting to start up.



The same procedure is used for both the primary and secondary fuel filter changes.

## 7. Fuel System Bleeding



**DANGER:**

DIESEL FUEL IS FLAMMABLE AND EXPLOSIVE UNDER CERTAIN CONDITIONS.

**WARNING:**

DIESEL FUEL IS HARMFUL TO SKIN. MAKE SURE THE RELEVANT PERSONAL PROTECTION EQUIPMENT IS WORN.

- Ensure the fuel tank is at least  $\frac{3}{4}$  full prior to undertaking this procedure.
- Open the bleed screw on top of the engine fuel filter (**Figure 20**).
- Operate the electric fuel pump by turning the ignition on.
- After the fuel filter has been purged of air, close the bleed screw.
- Undo **ALL** the injector pipe connections.
- Crank the engine over with the starter motor. When fuel can be seen, stop cranking.
- Tighten the injector pipe connections.
- Wipe off any excess fuel.
- Crank the engine.
- The engine should now start. If it does not start, repeat the above procedure.
- Check for any leaks and clean up any spilt fuel.



If the fuel filter are the only items being replaced, the injector pipes many not require bleeding.



**Figure 20: Fuel Filter Bleed Screw**

## 8. Cooling System



**DANGER:**

**SCALD HAZARD!** NEVER REMOVE THE COOLANT PRESSURE CAP IF THE ENGINE IS HOT. STEAM AND HOT COOLANT WILL SPURT OUT AND SERIOUSLY BURN YOU. TIGHTEN THE CAP SECURELY AFTER BEING REMOVED. STEAM CAN SPURT OUT DURING ENGINE OPERATION IF THE CAP IS LOOSE.



**WARNING:**

**BURN HAZARD!** WAIT UNTIL THE ENGINE COOLS BEFORE YOU DRAIN THE ENGINE COOLANT. HOT ENGINE COOLANT MAY SPLASH AND BURN YOU.

- To check the coolant level, ensure that the engine has been shut down for at least half an hour.
- The coolant level can be checked visually and should be between the two level marks formed on the front of the white plastic expansion tank.
- If required, top up the level with coolant (50% clean tap water and 50% ethylene glycol based anti-freeze) through the expansion tank filler cap.
- Do not use water only to top up as this weakens the coolant mix, reducing the level of frost protection and anti-corrosion protection of the coolant.

## 9. Belt Adjustment



**WARNING:**

**SEVERE HAZARD!** KEEP HANDS AND OTHER BODY PARTS AWAY FROM MOVING/ROTATING PARTS. WEAR TIGHT FITTING CLOTHING AND KEEP YOUR HAIR SHORT OR TIE BACK. REMOVE ALL JEWELLERY BEFORE COMMENCING WORK. CHECK BEFORE STARTING THE ENGINE THAT ANY TOOLS OR RAGS USED DURING MAINTENANCE HAVE BEEN REMOVED FROM THE AREA.

- Ensure the ignition key is removed before carrying out any adjustments.
- Turn the battery master switch to the off position before carrying out any adjustments

- Depress the longest run of the drive belt to be checked. If the travel exceeds 15-20mm using hard finger pressure, the belt needs re-tensioning.
- Loosen the upper adjuster on the alternator. Loosen the lower mounting pivot nut and bolt. Pull out either using hand pressure or using the tensioning screw, depending on which alternator belt is to be tensioned.
- Pull the alternator away from the engine to tighten the belt.
- Hold the alternator in position and retighten all the bolts



**If the belts are over tightened, alternator bearing failure will occur.**

## 10. Belt Maintenance



### **WARNING:**

**SEVERE HAZARD!** KEEP HANDS AND OTHER BODY PARTS AWAY FROM MOVING/ROTATING PARTS. WEAR TIGHT FITTING CLOTHING AND KEEP YOUR HAIR SHORT OR TIE BACK. REMOVE ALL JEWELLERY BEFORE COMMENCING WORK. CHECK BEFORE STARTING THE ENGINE THAT ANY TOOLS OR RAGS USED DURING MAINTENANCE HAVE BEEN REMOVED FROM THE AREA.

- Ensure the ignition key is removed before carrying out any maintenance.
- Turn the battery master switch to the off position before carrying out any maintenance.
- Do not allow oil to contact the belt. Oil attacks the construction of the belt. This reduces the drive efficiency and will cause it to fail prematurely.
- Replace the belt if it cracks or splits and as the adjustment nears the limit of travel.



**Some boat builders may remove one or more of the alternators during the installation of the engine. It is essential that when the alternators are refitted that the alignment is perfect or premature belt wear will occur.**

## 11. Belt Replacement



**WARNING:**

**SEVERE HAZARD!** KEEP HANDS AND OTHER BODY PARTS AWAY FROM MOVING/ROTATING PARTS. WEAR TIGHT FITTING CLOTHING AND KEEP YOUR HAIR SHORT OR TIE BACK. REMOVE ALL JEWELLERY BEFORE COMMENCING WORK. CHECK BEFORE STARTING THE ENGINE THAT ANY TOOLS OR RAGS USED DURING MAINTENANCE HAVE BEEN REMOVED FROM THE AREA.

- Ensure the ignition key is removed before replacing any belts.
- Turn the battery master switch to the off position before replacing any belts.
- Ensure that you have the correct replacement belts before starting this procedure. Some engines may have been fitted with non-standard optional alternators which may not use the belt sizes listed. Make a note of these belt sizes upon delivery.
- Loosen the top adjuster bolts and the lower mounting pivot nut and bolt.
- Push the alternator towards the engine to loosen the belt.
- Remove the belt.
- Hold the belt in position over the top alternator pulley. Rotate the engine if required by hand, to guide the new belt into the “vee”.
- Re-tension the belt as above.

## 12. Control Panel Maintenance



**WARNING:**

REMOVE THE IGNITION KEY BEFORE WORKING IN ENGINE COMPARTMENT.  
TURN BATTERY ISOLATION SWITCHES OFF.

- **To replace an illumination bulb:** Release the panel from its mounting. The bulbs are accessible from the rear of the panel. Remove the wires, unscrew the nut and pull out the bulb housing from the panel. Remove the bulb and replace. Refit bulb housing, screw the nut back up and refit the wires.
- **To replace any gauge:** Release the panel from its mounting. The gauges are accessible from the rear of the panel. Unplug the wire connectors, unscrew and pull the gauge out of the panel. Replace the gauge and refit. Reattach the wiring connectors.



Periodically squirt a lubricant into the key switch slot when the key has been removed (see Section 8 – Service Schedule). A lubricant such as WD40 – with silicon, would be suitable. Other lubricants are available. Then with the battery master switch turned off, operate the key switch a couple of times. This will ensure the lubricant works into the mechanism.

## SECTION 8 – Service Schedule



**NOTICE:**

REFER TO THE SHIRE MANUAL PRIOR TO CARRYING OUT ANY SERVICE OR MAINTENANCE WORK.



**WARNING:**

PRIOR TO CARRYING OUT ANY SERVICE OR MAINTENANCE WORK MAKE SURE THE RELEVANT PERSONAL PROTECTION EQUIPMENT IS WORN.

### 1. Specifications and Capacities

Specification of Coolants and Lubricants to use:

Component	Lubricant
Engine	SAE 15W 40 API Class CH-4 / CF-4 Oil
Coolant	50% Clean Water + 50% Ethylene Glycol Antifreeze
PRM 150 and 280 Gearbox	Engine Oil

Engine Oil Capacity (with Filter):

Engine	Capacity (Litres)	Capacity (Pints)
60,65	9.5	16.7

Gearbox Oil Capacity (Excluding Cooler):

Gearbox	Capacity (Litres)	Capacity (Pints)
PRM 150	1.4	2.5
PRM 280	1.5	2.7

## 2. Service Intervals

	Check	Change	Notes
<b>Engine Oil &amp; Filter</b>	Daily (Level)	Every 250 Hours OR 12 Months*	First change after 50 hours
<b>Gearbox Oil</b>	Weekly (Level)	Every 250 Hours OR 12 Months*	First change after 25 hours
<b>Coolant Level</b>	Daily (Level)	Every 24 Months	-
<b>Primary Fuel Filter **</b>	50 hours	At first 50 hour service and then every 250 hours OR 12 Months*	Drain water every 50 hours OR Monthly***
<b>Secondary Fuel Filter **</b>	-	Every 500 Hours OR 12 Months*	If large quantities of dirt or water are found in the Primary Fuel Filter then change at 250 hours
<b>Air Filter Element</b>	250 Hours	Every 750 hours OR 24 Months*	Sooner if required
<b>Drive Belts</b>	Daily	As required	Adjust as necessary
<b>All Hoses</b>	50 hours	As required	Check hoses for damage or leaks. Replace as necessary
<b>Key Switch</b>	Lubricate	Every 150 hours OR 12 Months*	As per instructions in Section 7 - Service Procedure

\* Whichever occurs first.

\*\* Only original filters which meet the Recreational Craft Directive/ Recreational Craft Regulation should be fitted to your engine

\*\*\* If large quantities of water are found in the fuel when the filter is drained, increase the frequency of draining.



**SECTION 9 – Wiring Diagrams**

**1. Engine Wiring Diagram Shire 60 & 65**

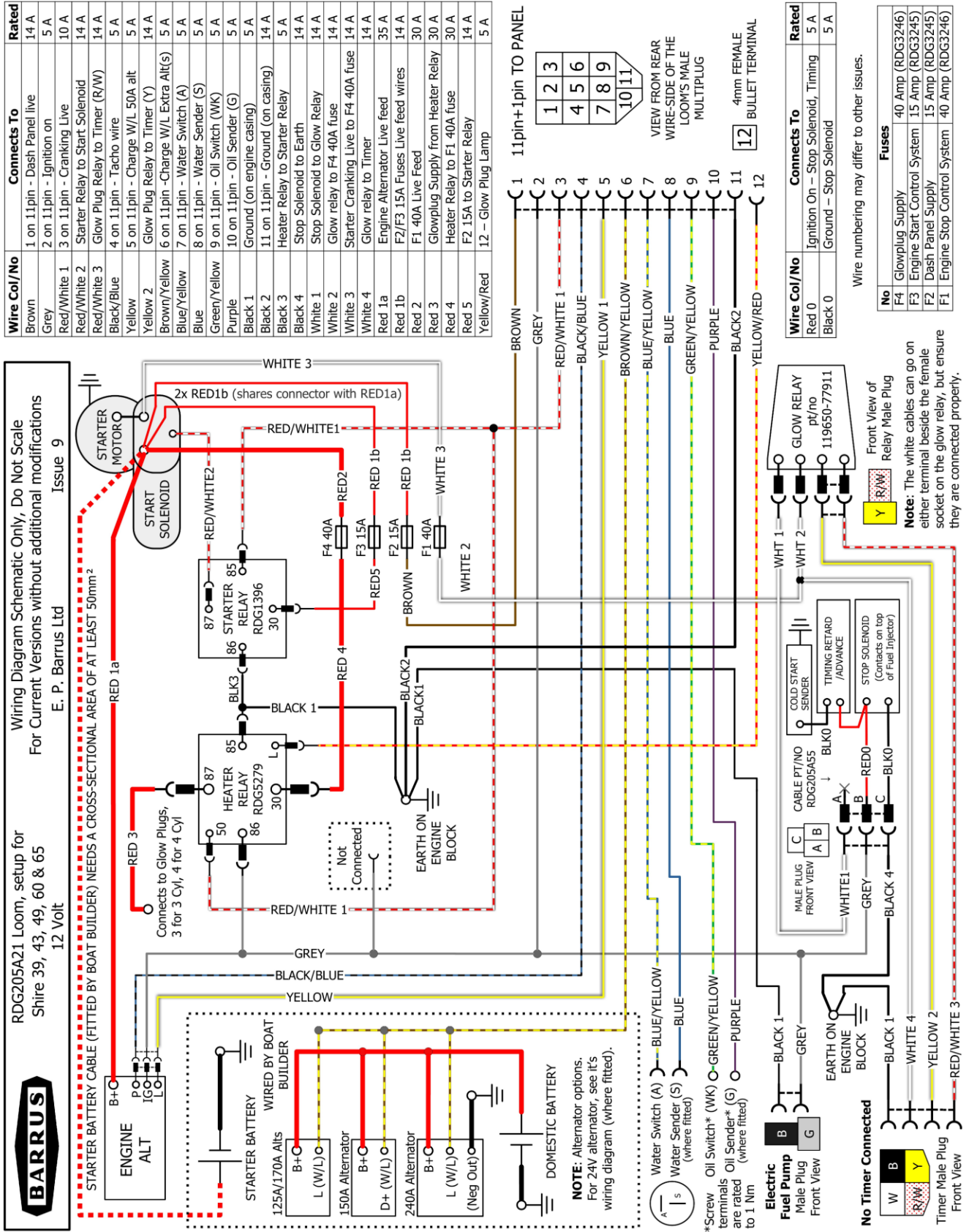

**Figure 21: Shire 60 & 65 Wiring Diagram**

2. Shire 60 & 65 Cold Start Wiring Diagram

Shire 39, 43, 49, 60 & 65 Cold Start Loom  
RDG205A55 - Issue 1

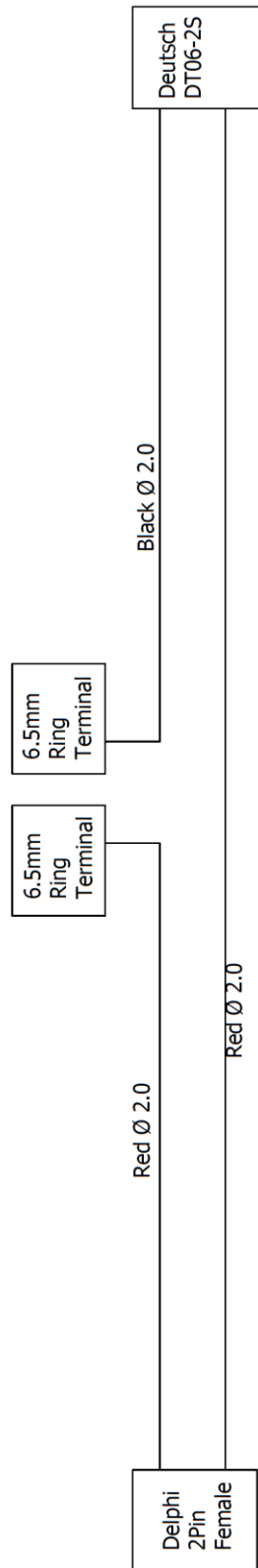

Figure 22: Shire 60 & 65 Cold Start Wiring Diagram

### 3. Standard Control Panel Wiring Diagram

August 2023

RDG20710110

SHIRE STANDARD PANEL WIRING

PIN NO.	WIRE COLOUR	CONNECTS TO
1	RED ø3	PANEL FEED
2	RED ø2	IGNITION ON
3	BLACK ø3	CRANKING LIVE
4	BLACK ø2	TACHO
5	YELLOW	CHARGE W/LIGHT 50A ALT
6	PINK	CHARGE W/LIGHT EXTRA ALT(s)
7	GREEN ø2	WATER TEMP WARNING
8	Not Used	ENGINE TEMP GAUGE SIGNAL
9	WHITE ø2	OIL PRESSURE WARNING
10	Not Used	OIL PRESSURE GAUGE SIGNAL
11	BLUE ø2	EARTH
12	BROWN ø2	GLOW PLUG LAMP

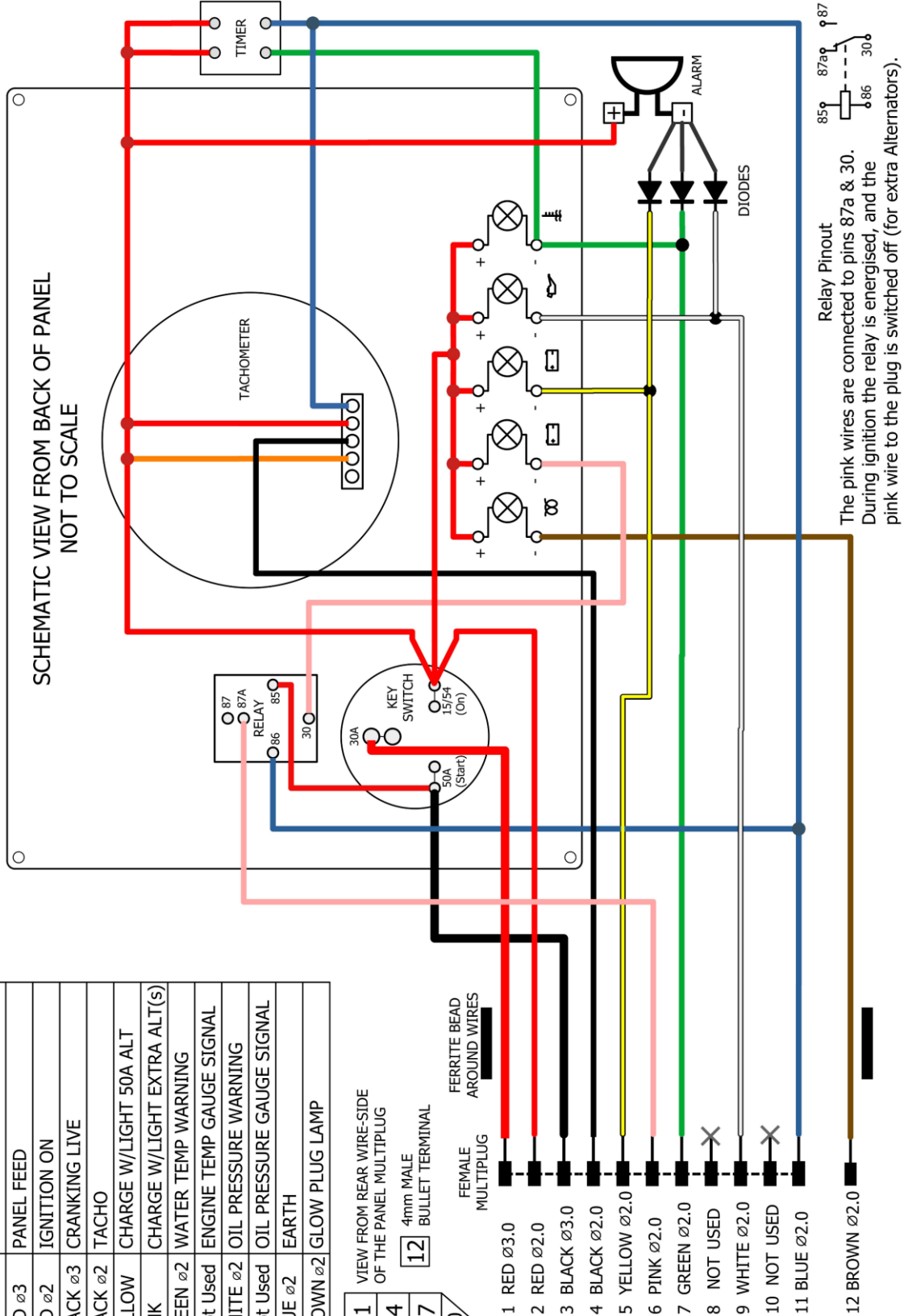
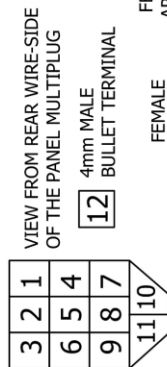

Relay Pinout  
The pink wires are connected to pins 87a & 30.  
During ignition the relay is energised, and the pink wire to the plug is switched off (for extra Alternators).

For current version of panels, without modifications. Standard voltage for system is 12V - see the wiring diagram(s) for the connected Loom(s) for more info

Figure 23: Standard Control Panel Wiring Diagram

4. Deluxe Control Panel Wiring Diagram

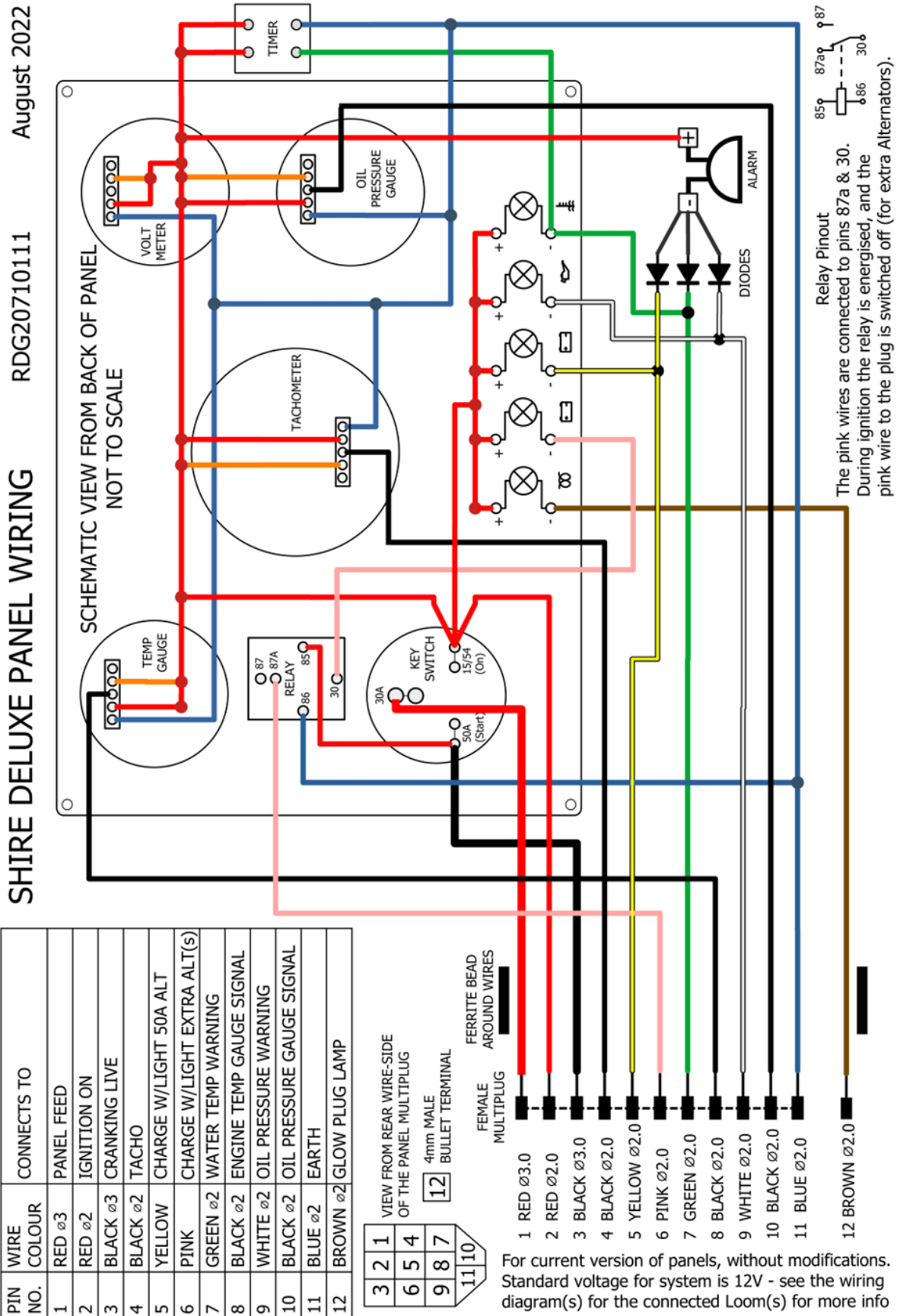
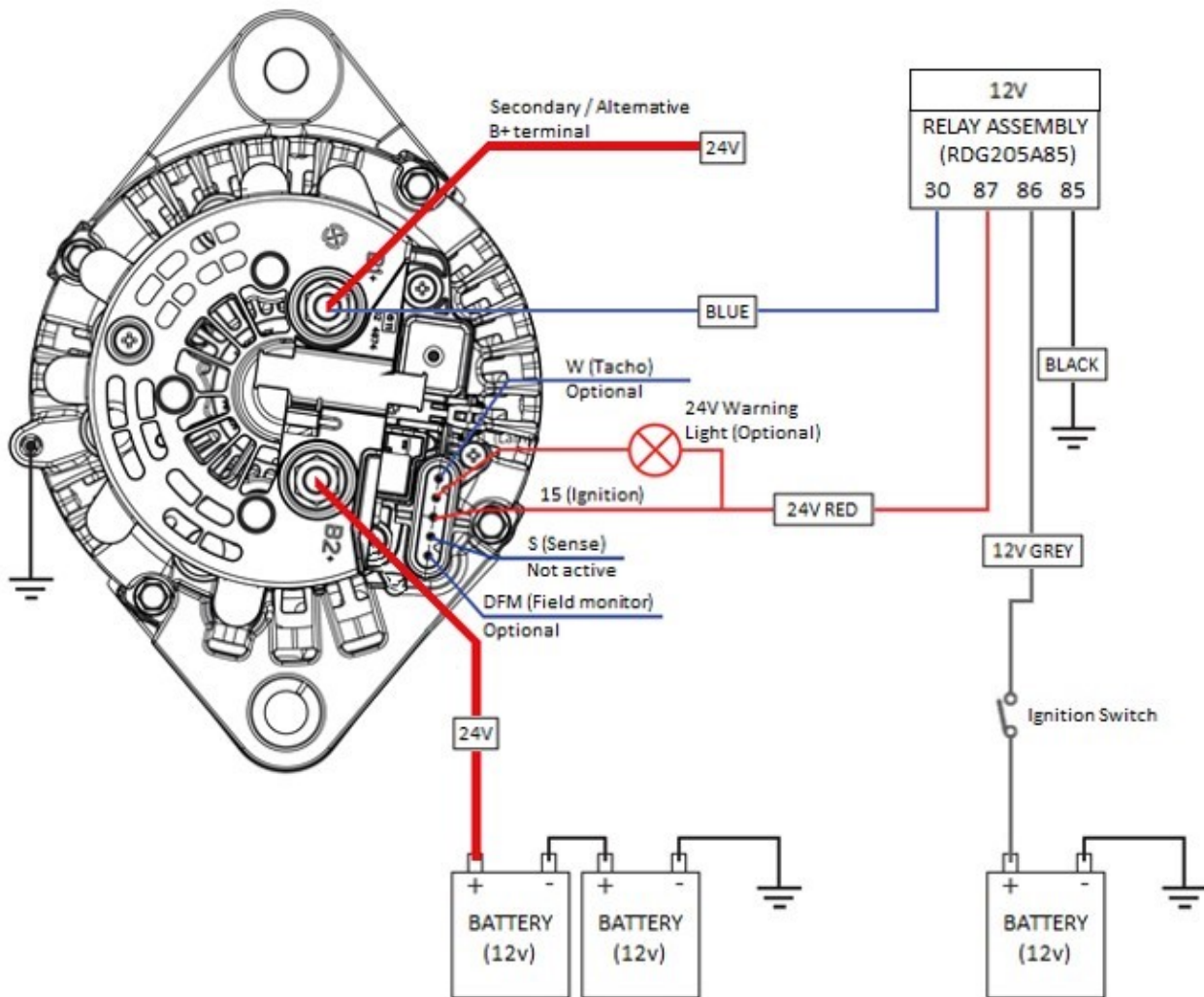

Figure 24: Deluxe Control Panel Wiring Diagram

**5. Prestolite 24 Volt 120 Amp Alternator Wiring Diagram**



**Figure 25: 24v 120A Alternator Wiring**



**Before wiring the 24 Volt 120 Amp Alternator please read the information below:**

- The S (Sense) terminal is not active on the AVI147J3110HD or AVI147J3113HD models so does not need connecting (on those two models).
- The W (Tacho) is an option (when a rev counter is fitted) and is not required for alternator functionality.
- The DFM (Field Monitor) usage is dependent on the engine and is not required for alternator functionality.
- The Terminal 15 (Ignition) provides excitation and **MUST** be connected.
- The L (Warning Lamp) is an option (when a warning lamp is fitted) and is not required for alternator functionality.

- The alternator is fitted with two B+ terminals. Either of the B+ terminals can be used.
- The alternator is earth return (grounded) Ensure there is a good earth connection to the engine.



**A 12v ignition operated relay may be required to switch on the 24v supply to Terminal 15 if the alternator is a stand alone item fitted to a 12v engine.**

- Use relay assembly RDG205A85
- Use relay RDG1396

## SECTION 10 – Technical Data

### 1. Engine Data

<b>Engine Model</b>	<b>Shire 60, 65</b>	
<b>Type</b>	Vertical In-Line Diesel Engine	
<b>Combustion System</b>	Direct Injection	
<b>Aspiration</b>	Turbocharged	
<b>Number of Cylinders</b>	4	
<b>Bore x Stroke</b>	87 x 103mm	
<b>Displacement</b>	2.449L	
<b>Rated Output/Speed</b>	<b>Shire 60</b> 44kW (60hp) at 2600rpm	<b>Shire 65</b> 48kW (65hp) at 2700rpm
<b>Low Idling</b>	875 - 900 rpm	
<b>High Idling</b>	2700 ±25 rpm	
<b>Direction of Rotation</b>	Anti-clockwise Viewed from Flywheel End	
<b>Lubricating System</b>	Pressure Splashing	
<b>Normal Oil Pressure at Rated Engine Speed</b>	0.25 – 0.4 MPa / 2.5 –4 bar / 36 – 58 psi	
<b>Normal Oil Pressure at Low Idle Speed</b>	0.068 MPa / 0.68 bar / 10 psi	
<b>Electric Starting System</b>	Starter Motor: DC12V	
	Starter Capacity: 2.3kW	
	Minimum Recommended Start Battery Capacity: 12V 100Ah	
<b>Valve Clearances (Exhaust and Inlet)</b>	0.2 ± 0.05mm	
<b>Maximum Turbo Outlet Pressure</b>	120 KPa / 1.2 bar / 17 psi	

Note: The 60T/65T base block is only 60hp

### 2. Return Diesel System

<b>Maximum Fuel Temp</b>	43°C
<b>Maximum Flow</b>	0.3 Litre / Min (3000 rpm)
<b>Flow at Idle</b>	0.1 Litre / Min

The flexible fuel lines used on the engine comply with ISO 7840.

### 3. Dry Weight of Engine Data

Dry Weight of Engine (Including Gearbox)*	
Model	Dry Weight (kg)
Shire 60	320kg
Shire 65	360kg

\* The dry weights stated are for the standard engine in each model range. If a different gearbox or additional alternators are ordered the weight will change accordingly.

### 4. Torque Settings for Screws, Bolts and Nuts

#### Main Bolts and Nuts

Name	Specification	Tightening Torque (Nm)	Tightening Torque (Degrees)
Main Bearing Cap Bolts	M10 x 1 (Grade 10.9)	First time: 30±1	Second time: 60±3°
Cylinder Head Bolts	M11 x 1.5 (Grade 10.9)	First time: 30 Second time: 50	Third time: 60° Fourth time: 60°
Connecting Rod Bolts	M8 x 1 (Grade 12.9)	First time: 25±1	Second time: 60±3°
Flywheel Bolts	M12 x 1.5 (Grade 12.9)	100±3	-
Glow Plugs	M10 x 1.25	20~25	-
Injector Clamp Plate Bolt	M8 x 1.25 (Grade 10.9)	20	-
Injection Pump Drive Shaft Nut	-	80~100	-
Crankshaft Pulley Bolt	M18 x 2 (Grade 10.9)	First time: 210+15	Second time: 60±2.5°

#### General Use Screws, Bolts and Nuts

	Thread Diameter					
	M6	M8	M10	M12	M14	M16
Grade 8.8	9~11	25~30	41~51	73~89	122~149	182~222
Grade 10.9	12~14	29~35	58~71	105~128	160~195	247~290



## 5. Cylinder Head Tightening Sequence

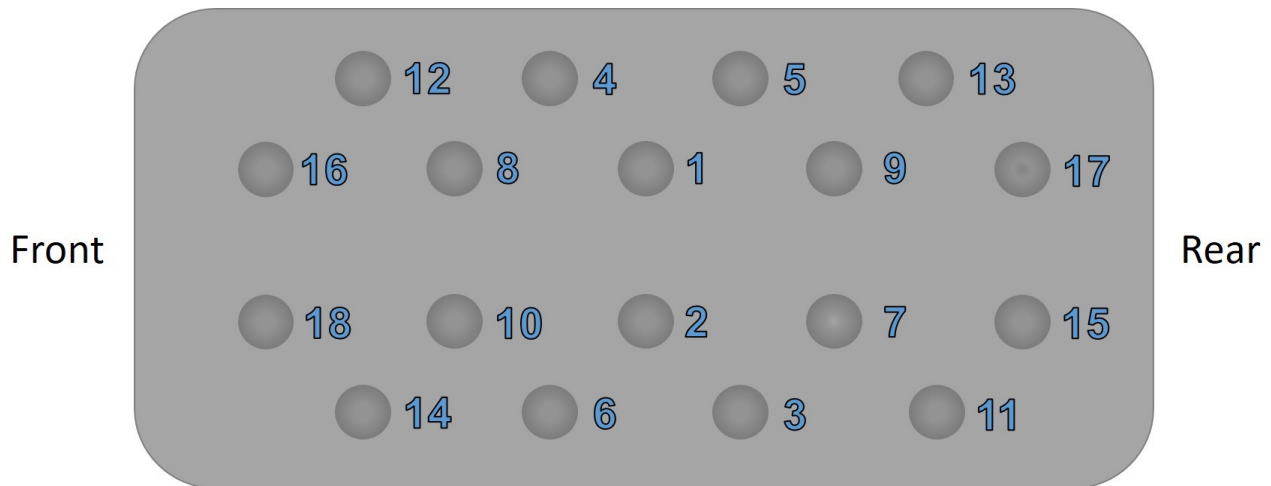

**Figure 26: Cylinder Head Tightening Sequence**

- Tighten all the cylinder head bolts to 30Nm following the sequence shown in **Figure 26**.
- Tighten all the cylinder head bolts to 50Nm following the sequence shown in **Figure 26**.
- Put a paint mark on each bolt as reference point.
- Turn all the cylinder head bolts 60° clockwise following the sequence shown in **Figure 26**.
- Turn all the cylinder head bolts a further 60° clockwise following the sequence shown in **Figure 26**.



The bolts can only be reused a **MAXIMUM** of two times

## 6. Fuel Injection Pump

If the fuel injection pump is removed and replaced for any reason, please be aware that there is no key or master spline on the injection pump drive shaft. To achieve the correct injection pump timing either look at the Stanadyne website or follow the instructions below:

- Make sure the timing lock pin on the fuel injection pump is in the unlocked position.

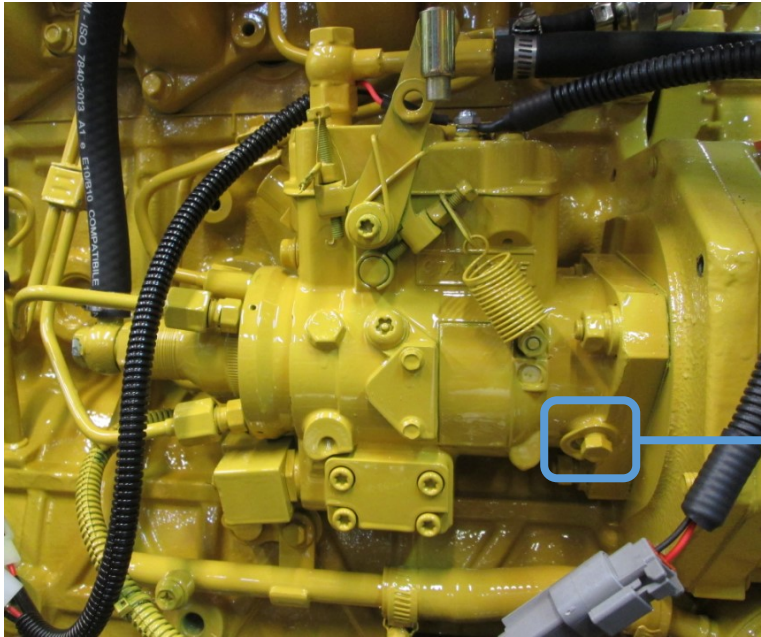

Lock pin in the unlocked position

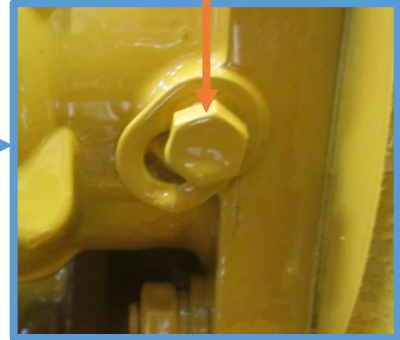

- Loosen the three nuts securing the fuel injection pump to the engine. Make sure the fuel injection pump is in the middle of its adjustment on the slots. When the fuel injection pump is in the middle of the slots retighten the nuts.

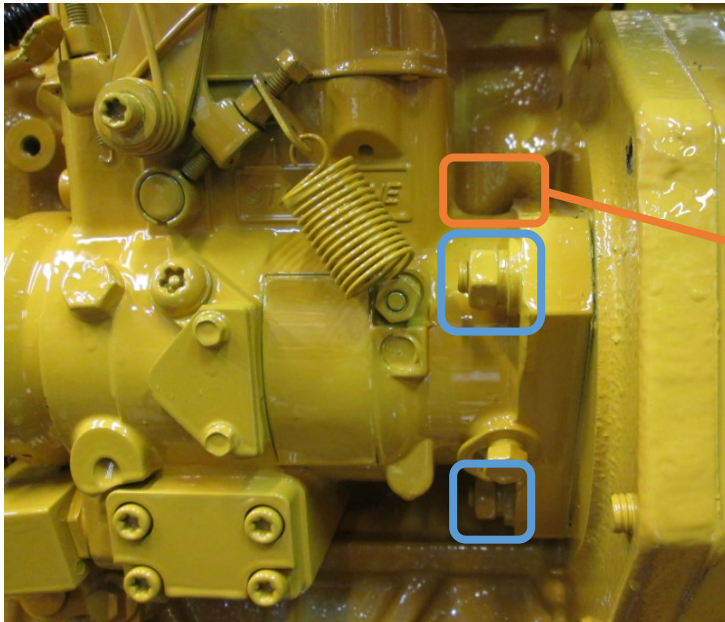

Nut to loosen

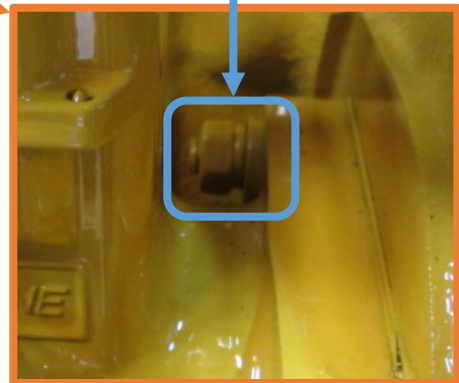

- Remove the front cover from the engine.

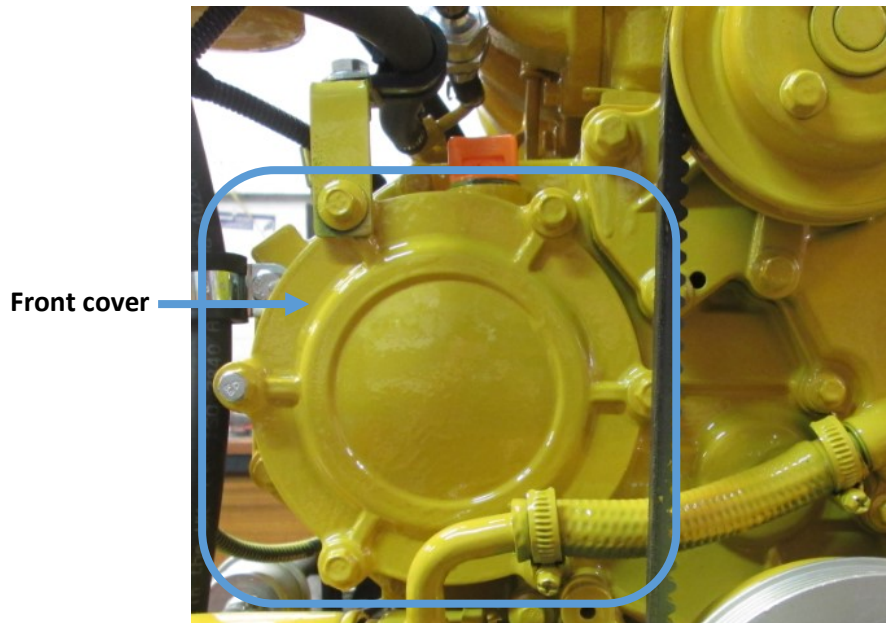

- Make sure the pump timing gear is loose on the pump shaft.

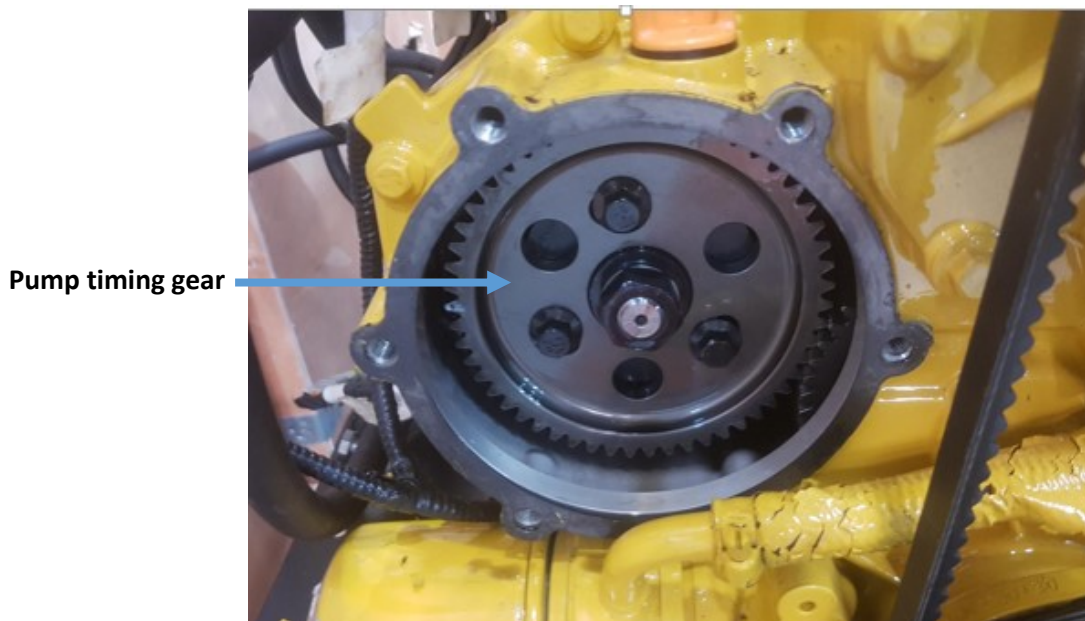

- Remove the timing window cover from the fuel injection pump.

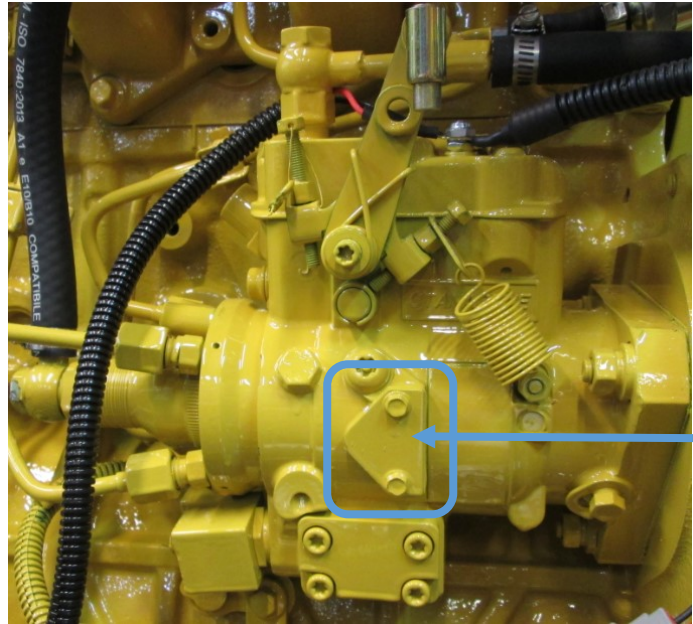

Timing window cover

- Make sure the line on the shaft and the line on the pump body line up.

**Two lines which need to line up**



- Put the timing lock pin on the fuel injection pump into the locked position. **NOTE: Do NOT attempt to rotate the pump shaft when the pump shaft timing is locked.**

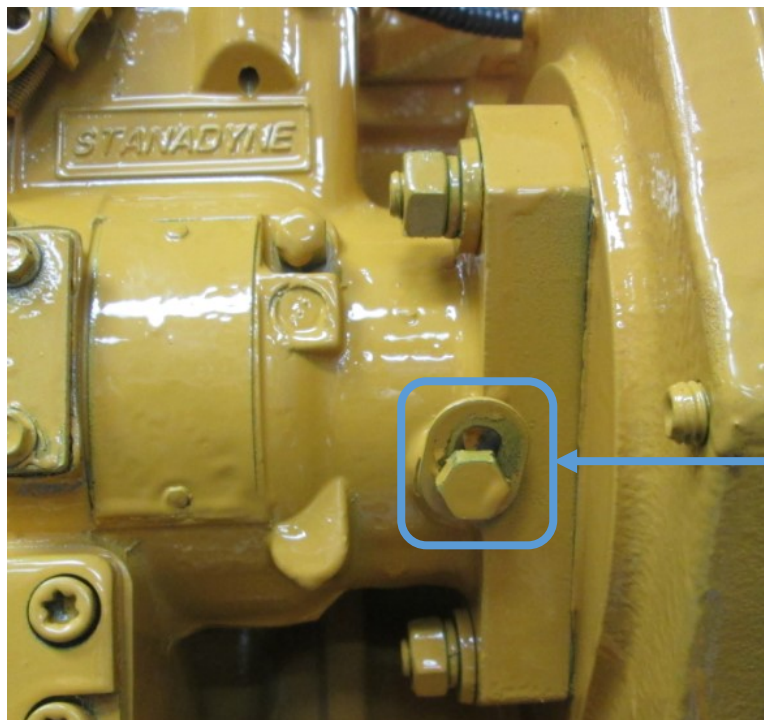

Lock pin in the locked position

- Rotate the engine (make sure the pump timing gear is rotating freely on the pump shaft) until the timing marks line up with 6° btdc with cylinder number 1 in compression.

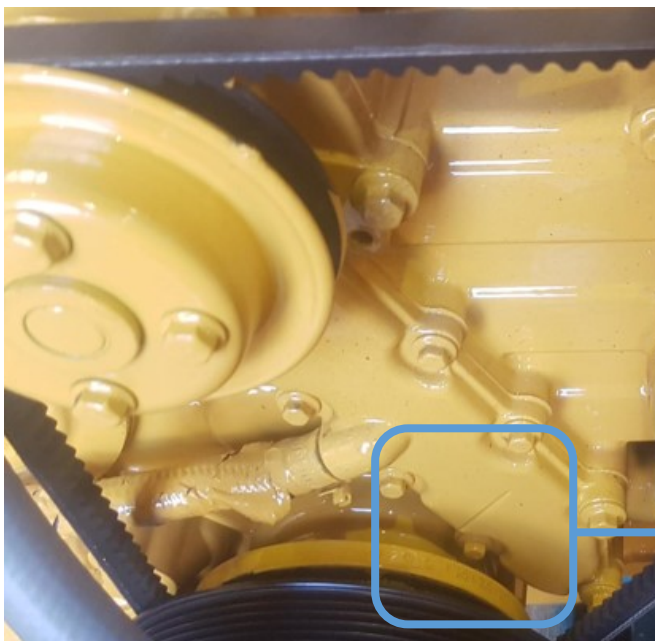

Timing marks lining up at 6° btdc with cylinder number 1 in compression



- Torque the pump timing gear to 25Nm on the pump shaft using a torque wrench.

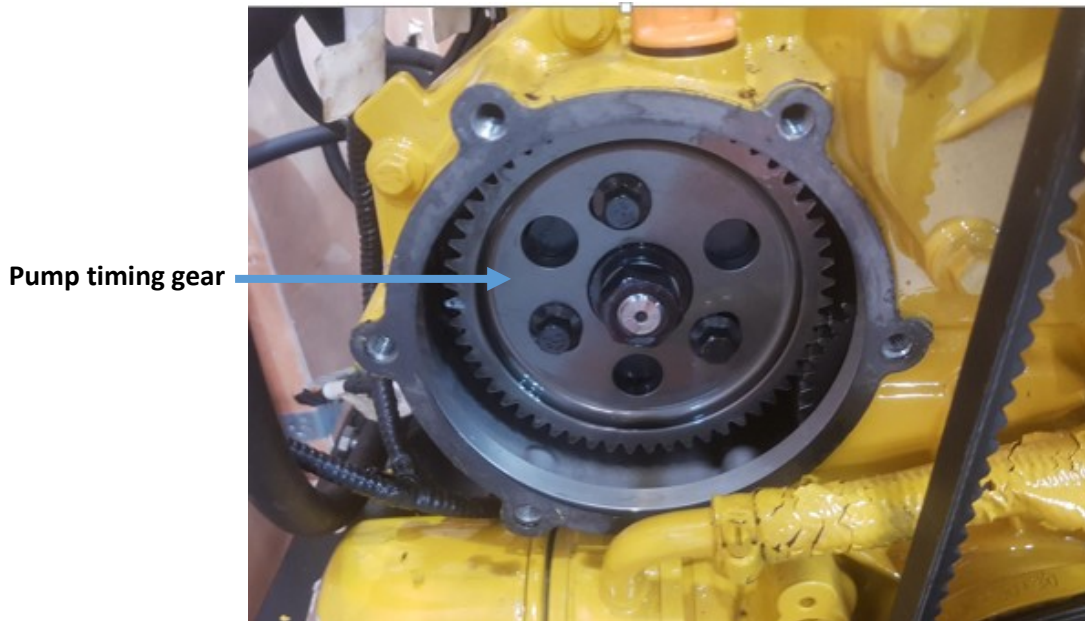

- Put the timing lock pin on the fuel injection pump back into the unlocked position.

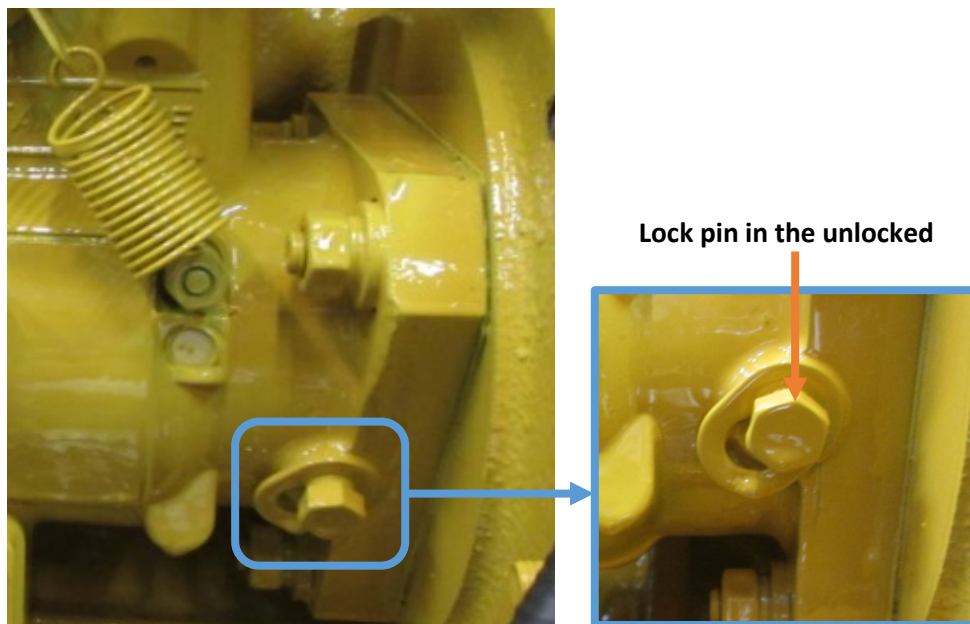

- Torque the pump timing gear to 50Nm on the pump shaft using a torque wrench.

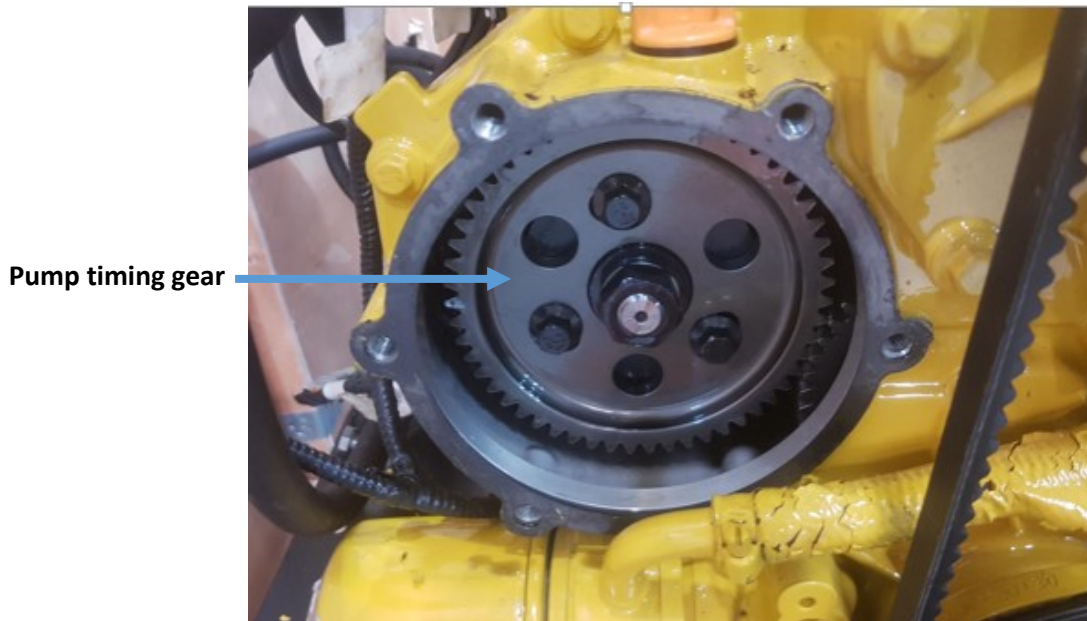

- Refit the front cover from the engine.

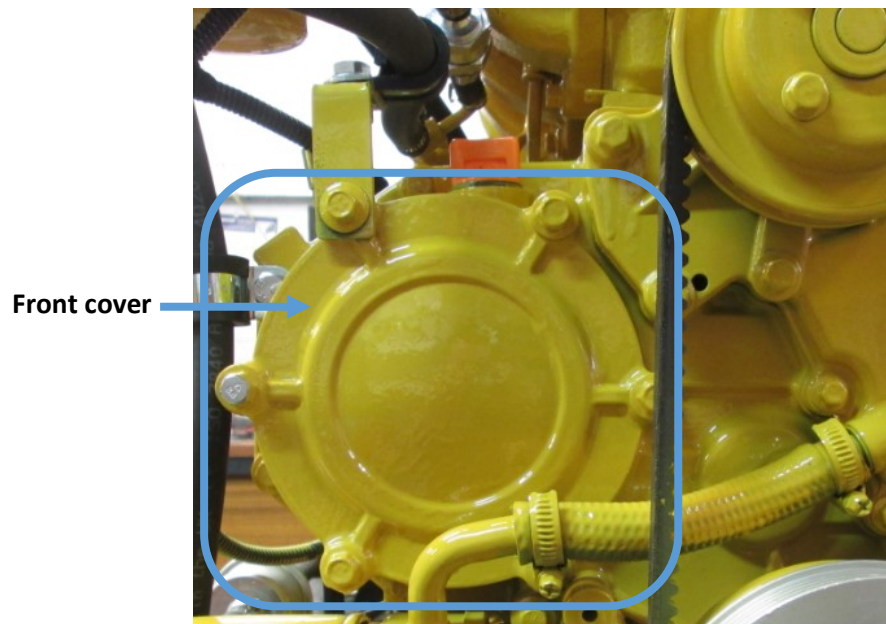

- Refit the timing window cover from the fuel injection pump. Torque the screws to 1.5 – 2.5Nm

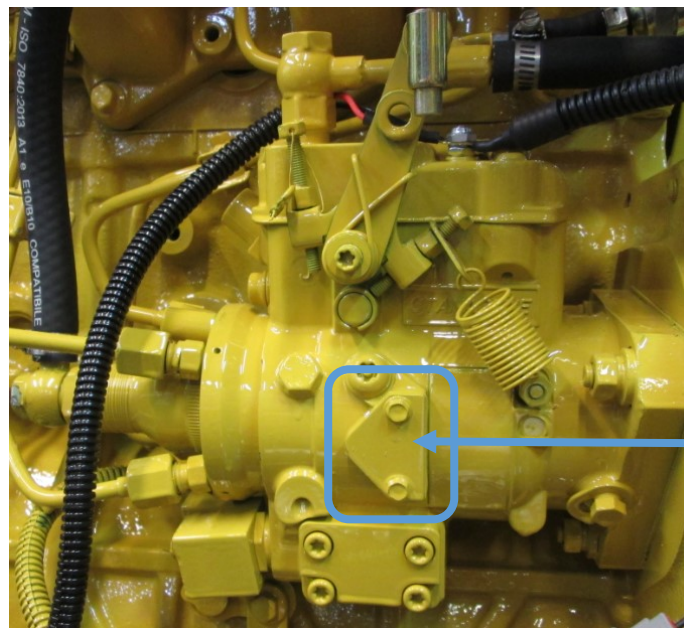

Timing window cover



## SECTION 11 – Dealer List

Area	Company	Telephone	Email
BERKSHIRE	Driveline Marine	0118 942 3877	tam@drivelinemarine.com
	Marcus Marine Engineering Ltd <i>(Servicing, Repairs &amp; Breakdowns only)</i>	07900890911	Marcus@marcusmarine.co.uk
BRISTOL	Advance Marine	01275 815910	phil@advancemarine.co.uk
CHESHIRE	Midland Chandlers	01928 751 800	preston.brook@midlandchandlers.co.uk
	Nantwich Canal Centre Ltd	01270 625122	info@nantwichcc.com
CUMBRIA	Windermere Aquatic Ltd	01539 442121	service@aquaticboatcentres.com
DERBYSHIRE	Midland Chandlers	01283 701445	willington@midlandchandlers.co.uk
DEVON	Sleeman & Hawken Ltd	01626 778266	sales@sleeman-hawken.co.uk
ESSEX	French Marine Motors Ltd	01206 305233 01255 850303	info@frenchmarine.com
HAMPSHIRE	Marine Power Ltd	0238 0403918	sales@marine-power.co.uk
HERTFORDSHIRE	Lee Valley Marina	01920 870499 01920 293101	stansteadmarina@vibrantpartnerships.co.uk
	Keypart Ltd	01923 276000	sales@keypart.com
LEICESTERSHIRE	Foxtan Boat Services Ltd	01162 792285	foxtanboats@btinternet.com
LONDON	Lee Valley Marina	020 88061717	springfieldmarina@vibrantpartnerships.co.uk
MIDDLESEX	Lindon Lewis Marine	01932 247427	service@pushtheboatout.com
NORTHAMPTON	Grand Junction Boat Co.	01604 858043	info@boatrepairs.uk.com
	Midland Chandlers	01788 891401	braunston@midlandchandlers.co.uk
NOTTINGHAM	Farndon Marina	01636 705483	info@farndonmarina.co.uk
STAFFORDSHIRE	JD Boat Services Ltd	01902 791811	david@jdboats.co.uk
	Midland Chandlers	01785 712437	penkridge@midlandchandlers.co.uk
	River Canal Rescue	01785 785680	enquiries@rivercanalrescue.co.uk
	Stone Boatbuilding Company	01785 812688	stonechandlery@aol.com
	Streethay Wharf	01543 414808	office@streethaywharf.co.uk
WARWICKSHIRE	Springwood Haven Leisure Ltd	0845 4566572	enquiries@springwoodhaven.co.uk
WILTSHIRE	Devizes Marina	01380 725300	sales@devizesmarina.com

WORCESTERSHIRE	Crafted Boats Ltd	01527 876438	craftedboats@btconnect.com
	Evesham Marina	01386 768500	info@eveshammarina.co.uk
	Starline Narrowboats	01531 632003	enquiries@starlinenarrowboats.co.uk
YORKSHIRE	Rodley Boat Centre	01132 576132	rodleyboatcentre@msn.com
MONMOUTHSHIRE	Castle Narrowboats	01873 830001	info@castle.narrowboats.co.uk
EIRE	Southshore Marina & Diesel Ltd	028383 41010	info@southshoremarine.co.uk

## SECTION 12 – Shire Parts

Model	Shire 60	Shire 65
Primary Fuel Filter	RDG9188346	RDG9188346
Secondary Fuel Filter	RDG9188345	RDG9188345
40A Alternator	R300037010003	R300037010003
40A Alt Belt	R300037010001	R300037010001
150A Alternator	RDG20110201	RDG20110201
150A Alt Belt	RDG2254	RDG2254
240A Alternator (Option)	RDG2019682	RDG2019682
240A Alt Belt (Option)	RDG6076	RDG6076
Air Filter Element	RDG5795	RDG5795
Oil Filter	R300010120001	R300010120001

### Control Panel:

Standard Control Panel	RDG20710110
Deluxe Control Panel (Option)	RDG20710111

### Fuses & Relays:

The electrical system is fitted with four blade type fuses:

1	Engine Stop Control System Fuse	40amp	RDG3246
2	Control Panel Supply Fuse	15amp	RDG3245
3	Engine Start Control System Fuse	15amp	RDG3245
4	Glow Plug Fuse	40amp	RDG3246
5	Cold Start Relay	-	RDG5279
6	Starter Relay	-	RDG1396



Figure 27: Fuses & Relays

### Engine Oil:

Engine Oil is available from your Shire Dealer in a 20 litre container (Part Number VC83070-020).

### Diesel Fuel Additive:

Diesel fuel additive is available from your Shire Dealer in a handy 500ml container (Part No RDG80210219).

### Shire Parts Book:

On the E.P Barrus Website there is a Shire 60 Parts Book and Shire 65 Parts Book which has a more extensive list of parts available for your engine. To access the Shire Parts Books on the internet type the following short link into your search engine:

<https://www.barrus.co.uk/divisions/marine/diesel/shire/downloads/shire-parts/?p=1>

## SECTION 13 – Afterlife Recycling

When it becomes necessary to dispose of your engine. This may be possible at recycling centre; however, it will likely require careful disassembly first before disposal. For further information please contact your local recycling centres for disposal advice to see what they will accept for disposal.

Engines are primarily steel, cast iron and aluminium; and are recyclable after removal of other parts. Larger components such as the engine block may only be handleable by a few centres, unlike say smaller plastic components.

Most of the other parts require special disposal as they include hazardous waste, and must be separated and declared upon disposal, including:

### Fluid Disposal

You must make sure that all unused oil, fuel and coolant is drained out carefully and disposed of correctly at a local recycling centre. Under NO circumstance must any oil, fuel or coolant be put down any drains or leaked into waterways or the environment.

Contact local recycling centres or garages, or check their websites to find out whether they take or recycle engine fluids. If they don't, they may be able to direct you to your nearest drop-off point depending on the volume. Recycle your coolant/oil/fuel in distinct well-sealed containers that are clearly labelled.

### Waste Electrical Electronic Equipment (WEEE) and Battery recycling

Parts contain WEEE waste or batteries should not be disposed of in your domestic waste. You should recycle WEEE or batteries in accordance with your local authority or recycling centre's directions. Batteries will need declaring separately for safety purposes.

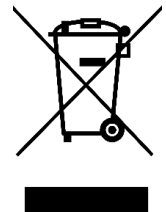

**Packaging materials** that are unwanted should be sorted, with cardboard, wood, and paper recycled where possible. Some Local Authorities and recycling centres may accept plastic bags, films and bubble wrap for recycling. Polystyrene is very rarely recycled and may have to be disposed of in general rubbish, inside bags.

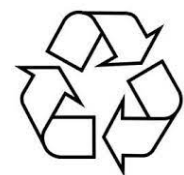

Reduce, Reuse,  
Recycle

For further information about disposal please contact your Local Authority. You can also get more advice and guidance about recycling in your area at the following website <http://www.recycle-more.co.uk>.

## SECTION 14 – Declarations

### 1. Declaration of Conformity for Recreational Craft Propulsion Engine with the requirements of Directive 2013/53/EU.

**Designation:** Marine engine for propulsion of, and incorporation into, watercraft.

**Description of Engine(s) and Essential Requirements:**

**Engine Type:** Inboard Engine

**Fuel Type:** Diesel

**Combustion Cycle:** 4 Stroke

Identification of Engine(s) covered by this Declaration of Conformity

Engine Model	Base Engine Type	Engine Family code	Type Approval Certificate Number	Serial Number(s)	and their derivatives
Shire 60	BS1511	4D24T00	HpiVS/R1105-008-I-02	XX-2400-X	
Shire 65					

**Name of Engine Manufacturer and Authorised Representative:** E.P. Barrus Ltd, Launton Road, Bicester, OX26 4UR, England, United Kingdom

**Authorised Compiler of Relevant Technical Documentation:** Mr. Phil James

**Name of Notified Body for exhaust emission assessment:** HPI Verification Services Ltd., The Manor House, Howbery Park, Wallingford, OX10 8BA, United Kingdom. ID Number: 1521

**Conformity assessment module used for exhaust emissions:** B+C B+D B+E B+F G H

**Other Community Directives applied:**

Essential Requirements	Standards	Other normative document/method.	Technical file	Specify in more detail *= Mandatory standard.
Annex 1.B- Exhaust Emissions				
B.1 Engine Identification	<input type="checkbox"/>	<input checked="" type="checkbox"/> RCD (II)	<input checked="" type="checkbox"/>	2013/53/EU
B.2 Exhaust emission requirements	<input checked="" type="checkbox"/> *	<input type="checkbox"/>	<input type="checkbox"/>	* EN ISO 8178 - 4:2007
B.3 Durability	<input type="checkbox"/>	<input checked="" type="checkbox"/>	<input type="checkbox"/>	2013/53/EU
B.4 Owner's Manual	<input checked="" type="checkbox"/>	<input type="checkbox"/>	<input checked="" type="checkbox"/>	ISO10240
Annex 1. C- Noise Emissions	See Declaration of Conformity of the craft in which the engine(s) has(have) been installed			

This declaration of conformity is issued under the sole responsibility of the authorised representative. I declare on behalf of the engine manufacturer that the engine will meet the exhaust emission requirements of Directive 2013/53/EU when installed in a recreational craft, in accordance with the instructions accompanying the engine and that this engine must not be put into service until the recreational craft into which it is to be installed has been declared in conformity with the relevant provisions of the Directive 2013/53/EU. In case of a reasoned request by the national authority, we will supply the relevant technical information of the above-named engines to the person in charge.



Tim Hart  
Sales Director

Signed: Bicester, UK

Date: 31/01/2019

## 2. Declaration of Conformity for Recreational Craft Propulsion Engine with the requirements of the Recreational Craft Regulations 2017 (UKCA Marking).

Name of Engine Manufacturer: <b>E.P.Barrus LTD</b>	
Name of Authorised Representative: <b>E.P.Barrus LTD</b>	
Address: <b>E.P.Barrus LTD, Launton Road, Bicester, Oxon, OX26 4UR, England, United Kingdom</b>	
Name of Notified Body for <u>exhaust emission assessment</u> : <b>HPi CEproof Ltd</b>	
Address: <b>HPi CEproof Ltd, The Manor House, Howbery Park</b>	
Town: <b>Wallingford</b>	Post Code: <b>OX10 8BA</b>
Country: <b>United Kingdom</b>	ID Number: <b>1521</b>
Conformity assessment module used for exhaust emissions: <input type="checkbox"/> B+C <input type="checkbox"/> B+D <input type="checkbox"/> B+E <input type="checkbox"/> B+F <input type="checkbox"/> G <input type="checkbox"/> H	
Or engine type-approved according to: <b>Directive 2013/53/EU</b>	
Other Community Directives applied:	

### Description of Engine(s) and Essential Requirements

**Engine Type:** Inboard Engine      **Fuel Type:** Diesel      **Combustion Cycle:** 4 Stroke  
**Identification of Engine(s) covered by this Declaration of Conformity**

Engine Model	Engine Type	Engine Family code	Type Approval Certificate Number
Shire 60 / 65	BS1511	4D24T00	HPIUK-R1105-T008-I-01-00

Essential Requirements	Standards	Other normative document/method.	Technical file	Specify in more detail * = Mandatory standard.
Annex 1.B- Exhaust Emissions				
B.1 Engine Identification	<input type="checkbox"/>	<input checked="" type="checkbox"/> RCD (II)	<input checked="" type="checkbox"/>	2013/53 EU
B.2 Exhaust emission requirements	<input checked="" type="checkbox"/> *	<input type="checkbox"/>	<input type="checkbox"/>	* EN ISO 8178-4:2017 Test Cycle 1
B.3 Durability	<input type="checkbox"/>	<input type="checkbox"/>	<input type="checkbox"/>	2013/53 EU
B.4 Owner's Manual	<input checked="" type="checkbox"/>	<input type="checkbox"/>	<input type="checkbox"/>	ISO10240
Annex 1. C- Noise Emissions	See Declaration of Conformity of the craft in which the engine(s) has(have) been installed			

This declaration of conformity is issued under the sole responsibility of the manufacturer. I declare on behalf of the engine manufacturer that the engine(s) [is (are) in conformity with the type(s) for which above mentioned EC type-examination or type approval certificate(s) has (have) been issued and]¹ will meet the requirements of the Recreational Craft Regulations 2017 when installed in a recreational craft, in accordance with the engine manufacturer's supplied instructions and that this (these) engine(s) must not be put into service until the recreational craft which it is (they are) to be installed has been declared in conformity with the relevant provisions of the above mentioned Directives.



Tim Hart  
Sales Director  
Signed: Bicester, UK  
Date: 07/07/2021

### 3. Declaration of Incorporation of Partly Completed Machinery

(Original declaration according to Directive 2006/42/EC, Annex II, part 1B)

1. The manufacturer:	E. P. Barrus Limited Glen Way Launton Road Bicester OX26 4UR England United Kingdom		
2. Authorised Compiler of Relevant Technical Documentation:	Mr. Phil James Glen Way Launton Road Bicester OX26 4UR England United Kingdom		
3. Partly Completed Machinery:	Designation:	Marine engines for propulsion of, and incorporation into, watercraft.	
	Description:		Serial No.:
		Shire 60	XX-2400-X
	Shire 65	and their derivatives.	
Base Engine:	BS1511		
4. The essential health and safety requirements of the Directive 2006/42/EC, Annex I, relating to the design and construction of the engine have been applied and fulfilled as shown in Annex A of this Declaration. The relevant technical documentation is compiled in accordance with part B of Annex VII of the Directive.			
5. In case of a reasoned request by the national authority, we will supply the relevant technical information of the above named engines to the person in charge.			
6. This partly completed machinery must not be put into service until the final machinery into which it has been incorporated has been declared in conformity with the provisions of this directive, where appropriate.			
7. This declaration is made on 31 January 2019 in Bicester, Oxfordshire.			
  Tim Hart Sales Director E. P. Barrus Limited			



## ANNEX A

The essential health and safety requirements for machinery can only be made compliant partly by Barrus. Therefore Barrus recommends to double-check the paragraphs from Annex 1 of the Directive 2006/42/EC mentioned below for compliance with the Directive for your particular machine.

Chapter	Subject	Applied	Fulfilled	Remark
<b>1.1 GENERAL REMARKS</b>				
1.1.2	Principles Of safety Integration	Yes *1	Yes*1	Consult accompanying manuals for instructions on safe installation.
	*1 For the following principles mentioned in the Directive: (a) the design and construction is fit for function as a marine engine; (b) risks have been eliminated or reduced as far as possible; Principles (c), (d) and (e) require measures to be taken by the boat builder for compliance with the directive.			
1.1.3	Materials and Products	Yes *2	Yes *2	
	*2 The engine has been designed and built using materials which are not known to present a hazard to safety or health. Use recommended fluids and filling positions only. Refer to manual for further information. Other materials used during the installation are to be designed and assessed by the boat builder.			
1.1.4	Lighting	Not Applicable		By boat builder/installer.
1.1.5	Design of machinery to facilitate its handling	Yes	Yes	All engines have appropriate packaging and lifting eyes
1.1.6	Ergonomics	Not Applicable		By boat builder/installer.
1.1.7	Operating Positions			
1.1.8	Seating			
<b>1.2 CONTROL SYSTEMS</b>				
1.2.1	Safety and reliability of control systems	Yes *3	No *3	
	*3 The control systems are designed and constructed to withstand the intended operating stresses and external influences. A fault in the hardware or software of the control system, errors in the control system logic, or reasonably foreseen human error during operation does not lead to hazardous situations. The operation of the control systems is to be designed and implemented by the boat builder. Contact Barrus for advice if required.			
1.2.2	Control devices	Yes *4	No *4	
	*4 The engine is fitted with the basic required control devices. The location and operation of these, and other, control systems is to be designed and implemented by the boat builder. Contact Barrus for advice if required.			
1.2.3	Starting	Yes *5	No *5	Starter motor installed
	*5 The operation of the starting system is controlled by a key switch on the panel. Contact Barrus for advice if required. The location and operation of this, and other, control systems is to be designed and implemented by the boat builder. Contact Barrus for advice if required.			
1.2.4.1	Normal stop	Yes *6	No *6	
	*6 The operation of the starting system is controlled by a key switch on the panel. The engine is fitted with a control device (energized to run stop solenoid) whereby it can be brought safely to a complete stop. The location and operation of this, and other, control systems is to be designed and implemented by the boat builder. Contact Barrus for advice if required.			
1.2.4.2	Operational stop	Not applicable		By boat builder/installer.
1.2.4.3	Emergency stop			
1.2.4.4	Assembly of machinery			
1.2.5	Selection of control or operating modes			
1.2.6	Failure of power supply			

1.3 PROTECTION AGAINST MECHANICAL HAZARDS				
1.3.1	Risk of loss of stability	Yes <sup>*7</sup>	Yes <sup>*7</sup>	
	<sup>*7</sup> Lifting eyes are provided on the engine. The secure and stable installation of engine is to be carried out by the boat builder/installer.			
1.3.2	Risk of break-up during operation	Yes <sup>*8</sup>	Yes <sup>*8</sup>	
	<sup>*8</sup> Instructions to indicate the type and frequency of inspections and maintenance required for safety reasons are in the accompanying manual. The mounting, positioning and/or guarding of parts where a risk of rupture or disintegration remains (in particular V-belts and pulleys), are to be made compliant by the boat builder/installer.			
1.3.3	Risks due to falling or ejected objects	Not applicable		
1.3.4	Risks due to surface edges or angles	Yes	Yes	
1.3.5	Risks related to combined machinery	Not applicable		By boat builder/installer.
1.3.6	Risks related to variations in operating conditions			
1.3.7	Risks related to moving parts	No	No	By boat builder/installer.
1.3.8	Choice of protection against risks arising from moving parts	No	No	
1.3.8.1	Moving transmission parts	No	No	
1.3.8.2	Moving parts involved in the process	Not applicable		By boat builder
1.3.9	Risks of uncontrolled movements			
1.4 REQUIRED CHARACTERISTICS OF GUARDS AND PROTECTIVE DEVICES				
1.4.1	General requirements	No	No	Guards to be specified and fitted by the boat builder/installer.
1.4.2.1	Fixed guards	No	No	
1.4.2.2	Interlocking movable guards	Not applicable		By boat builder/installer.
1.4.2.3	Adjustable guards restricting access			
1.4.3	Special requirements for protective devices			
1.5 RISKS DUE TO OTHER HAZARDS				
1.5.1	Electricity supply	Not applicable		By boat builder
1.5.2	Static electricity	Not applicable		By boat builder
1.5.3	Energy supply other than electricity	Yes <sup>*9</sup>	Yes <sup>*9</sup>	This concerns the fuel injection system and gearbox hydraulic system where fitted.  <sup>*9</sup> For the fuel filter, fuel injection pump, fuel injection nozzles, high pressure fuel injection pipes and fuel hoses supplied and installed on the engine by Barrus. Any other fuel system parts connected to the engine to be made compliant by the boat builder/installer.
1.5.4	Errors of fitting	No	No	Fitting or refitting should only be done by trained and skilled personnel.
1.5.5	Extreme temperatures	Yes <sup>*10</sup>	Yes <sup>*10</sup>	Protection or warnings to be made by the boat builder
<sup>*10</sup> 'Hot Surface' warning stickers are affixed to the rocker cover and/or the twin thermostat housing. All other protection or warnings to be made by the boat builder				
1.5.6	Fire	No	No	By boat builder
1.5.7	Explosion	No	No	

1.5.8	Noise	No	No	
1.5.9	Vibrations	No	No	
1.5.10	Radiation	No	No	
1.5.11	External radiation	Yes	Yes	
1.5.12	Laser radiation	Not applicable		
1.5.13	Emissions of hazardous materials and substances	Yes <sup>*11</sup>	Yes <sup>*11</sup>	
	<sup>*11</sup> Except for the exhaust, fuel, and cooling water system which needs to be properly connected by the boat builder or installer according to the Shire Manual.			
1.5.14	Risk of being trapped in a machine	Not applicable		By boat builder/installer.
1.5.15	Risk of slipping, tripping or falling			
1.5.16	Lighting			
<b>1.6 MAINTENANCE</b>				
1.6.1	Machinery maintenance	Yes	Yes	
1.6.2	Access to operating positions and servicing points	Not applicable		By boat builder/installer.
1.6.3	Isolation of energy sources			
1.6.4	Operator intervention			
1.6.5	Cleaning of internal parts	Yes	Yes	
<b>1.7 INFORMATION</b>				
1.7.1	Information and warnings on the machinery	Yes <sup>*12</sup>	Yes <sup>*12</sup>	
	<sup>*12</sup> A 'Refer to manual before carrying out engine installation, operation and maintenance' label is fitted to the engine. 'Hot Surface' warning stickers are fitted on surfaces that may become hot during operation. All other protection or warnings to be made by the boat builder/installer.			
1.7.1.1	Information and information devices	Yes <sup>*13</sup>	Yes <sup>*13</sup>	
	<sup>*13</sup> The control panel is simple to understand and use. Other control measures and information on the use of the machinery is to be carried out by the boat builder/installer.			
1.7.1.2	Warning devices	Yes <sup>*14</sup>	Yes <sup>*14</sup>	
	<sup>*14</sup> The control panel provides warnings. The location and installation of the control panel is to be carried out by the boat builder/installer.			
1.7.2	Warning of residual risks	No	No	By boat builder/installer.
1.7.3	Marking of machinery	Yes <sup>*15</sup>	No <sup>*15</sup>	
	<sup>*15</sup> The engine is CE marked with a brand, model designation and serial number. Full CE compliance to be carried out by the boat builder/installer.			
1.7.4	Instructions	Yes	Yes	
1.7.4.1	General principles for the drafting of instructions	Yes <sup>*16</sup>	Yes <sup>*16</sup>	
	<sup>*16</sup> For (a) and (b). The boat builder/installer to comply with (c) and (d) for the total machine and use of it			
1.7.4.2	Contents of the instructions	Yes <sup>*17</sup>	Yes <sup>*17</sup>	
	<sup>*17</sup> For (a), (b), (d), (e), (g), (h), (i), (k), (p), (r), (s), (t). The boat builder/installer to comply with (c), (d), (f), (g), (h), (i), (j), (l), (m), (n), (o), (q), (u), (v).			
1.7.4.3	Sales literature	Yes	Yes	

#### 4. EU Declaration of Conformity with the Exhaust Emissions Requirements of Directive 2013/53/EU

(Original declaration according to Directive 2013/53/EU)

1. The manufacturer:	E. P. Barrus Limited Glen Way Launton Road Bicester OX26 4UR		
2. Authorised Compiler of Relevant Technical Documentation:	Mr. Phil James Glen Way Launton Road Bicester OX26 4UR		
3. Partly Completed Machinery:	Designation:	Marine engines for propulsion of, and incorporation into, watercraft.	
	Description:		Serial No.:
		Shire 60	XX-2400-X
		Shire 65	
	Base Engine:	BS1511	
4. The engines detailed in section 3 comply with measures against the emission of gaseous and particulate pollutants from internal combustion engines. The engines comply with Directive 2013/53/EU (Recreational Craft Directive), Article 6, part 4 in that the engine will continue to meet the exhaust emission requirements of Directives, when installed into watercraft in accordance with the installation instructions that accompany the engine.			
5. In case of a reasoned request by the national authority, we will supply the relevant technical information of the above named engines to the person in charge.			
6. This partly completed machinery must not be put into service until the final machinery into which it has been incorporated has been declared in conformity with the provisions of this directive, where appropriate.			
7. This declaration is made on 31 January 2019 in Bicester, Oxfordshire.			
<div style="text-align: center;">  </div> <p>Tim Hart Sales Director E. P. Barrus Limited</p>			

## SECTION 15 – Lubricant Safety Data Sheets

### 1. Ground Force 10W-40

#### SAFETY DATA SHEET Ground Force 10W-40

##### SECTION 1: Identification of the substance/mixture and of the company/undertaking

###### 1.1. Product identifier

Product name		Ground Force 10W-40
Product number	7450	
Internal identification		GHS21580
REACH registration number		n/a Mixture

###### 1.2. Relevant identified uses of the substance or mixture and uses advised against

Identified uses	Engine oil.
Uses advised against	Non specified unless otherwise stated within this MSDS

###### 1.3. Details of the supplier of the safety data sheet

Supplier	Morris Lubricants Castle Foregate Shrewsbury SY1 2EL  08.45 - 17.00 GMT T: (+44)(0)1743 232200 F: (+44)(0)1743 353584 sds@morris-lubricants.co.uk
----------	---

###### 1.4. Emergency telephone number

Emergency telephone +44 (0)1743 232200 (08.45 - 17.00 hrs GMT)

##### SECTION 2: Hazards identification

###### 2.1. Classification of the substance or mixture

###### Classification

Physical hazards	Not Classified
Health hazards	Not Classified
Environmental hazards	Not Classified
Classification (67/548/EEC or 1999/45/EC)	Not Classified

###### 2.2. Label elements

Hazard statements	NC Not Classified
Supplemental label Information	EUH210 Safety data sheet available on request.

###### 2.3. Other hazards

This product does not contain any substances classified as PBT or vPvB.

## SECTION 3: Composition/information on ingredients

### 3.2. Mixtures

Distillates (petroleum) solvent-dewaxed heavy paraffinic	30-60%
CAS-No.: 64742-65-0	EC No.: 265-169-7
REACH registration number: 01-2119471299-27-XXXX	
A petroleum product. DMSO extract < 3 % weight ( IP 346 )	
Classification Not classified.	Classification (67/548/EEC or 1999/45/EC) -
Distillates,hydrotreated heavy paraffinic	10-30%
CAS number: 64742-54-7	EC number: 265-157-1
REACH registration number: 01-2119484627-25-0014	
Classification Asp. Tox. 1 - H304	Classification (67/548/EEC or 1999/45/EC) -
Highly refined mineral oil (C15 - C50)	1-5%
CAS number: -	EC number: 276-738-4
REACH registration number: 01-2119474889-13-XXXX	
Classification Asp. Tox. 1 - H304	Classification (67/548/EEC or 1999/45/EC) -

The Full Text for all R-Phrases and Hazard Statements are Displayed in Section 16.

**Composition comments** If REACH registration numbers do not appear the substance is either exempt from registration, does not meet the minimum volume threshold for registration, the registration date has not yet come due or this information is proprietary.

## SECTION 4: First aid measures

### 4.1. Description of first aid measures

<b>General information</b>	Get medical attention if any discomfort continues.
<b>Inhalation</b>	If spray/mist has been inhaled, proceed as follows. Move affected person to fresh air and keep warm and at rest in a position comfortable for breathing. Get medical attention if any discomfort continues.
<b>Ingestion</b>	Get medical attention if any discomfort continues. Do not induce vomiting.
<b>Skin contact</b>	Remove contaminated clothing immediately and wash skin with soap and water.
<b>Eye contact</b>	Rinse immediately with plenty of water. Remove any contact lenses and open eyelids wide apart. Continue to rinse for at least 15 minutes. Get medical attention promptly if symptoms occur after washing.

### 4.2. Most important symptoms and effects, both acute and delayed

<b>General information</b>	If aspiration into the lungs is suspected, eg when vomiting, admit to hospital immediately.
<b>Inhalation</b>	Upper respiratory irritation.
<b>Ingestion</b>	May cause discomfort if swallowed. The product contains mineral oil, which if aspirated into the lungs through vomiting after ingestion, may result in chemical pneumonia.
<b>Skin contact</b>	Prolonged contact may cause redness, irritation and dry skin.
<b>Eye contact</b>	Irritation of eyes and mucous membranes.

### 4.3. Indication of any immediate medical attention and special treatment needed

**Notes for the doctor** Treat symptomatically.

---

## SECTION 5: Firefighting measures

---

### 5.1. Extinguishing media

<b>Suitable extinguishing media</b>	Extinguish with foam, carbon dioxide, dry powder or water fog.
<b>Unsuitable extinguishing Media</b>	Do not use water jet as an extinguisher, as this will spread the fire.

### 5.2. Special hazards arising from the substance or mixture

<b>Specific hazards</b>	Heat from fire could result in drums bursting
<b>Hazardous combustion Products</b>	Protection against nuisance dust must be used when the airborne concentration exceeds 10 mg/m <sup>3</sup> . Oxides of carbon. Oxides of nitrogen. Fire may also create other unidentified organic gases some of which may be toxic.

### 5.3. Advice for firefighters

<b>Protective actions during Firefighting</b>	Control run-off water by containing and keeping it out of sewers and watercourses.
<b>Special protective equipment for firefighters</b>	Wear self-contained breathing apparatus.

---

## SECTION 6: Accidental release measures

---

### 6.1. Personal precautions, protective equipment and emergency procedures

<b>Personal precautions</b>	For personal protection, see Section 8. In case of spills, beware of slippery floors and surfaces.
-----------------------------	--

### 6.2. Environmental precautions

<b>Environmental precautions</b>	Contain spillage with sand or earth. Avoid the spillage or runoff entering drains, sewers or watercourses. The product is insoluble in water and will spread on the water surface.
----------------------------------	--

### 6.3. Methods and material for containment and cleaning up

<b>Methods for cleaning up</b>	Contain spillage with sand or earth. Collect spillage for reclamation or disposal in sealed containers via a licensed waste contractor. Avoid water contacting spilled material or leaking containers. Spillages or uncontrolled discharges into watercourses must be reported immediately to the Environmental Agency or other appropriate regulatory body. In case of spillage on water prevent the spread by use of suitable barrier equipment
--------------------------------	---

### 6.4. Reference to other sections

<b>Reference to other sections</b>	For personal protection, see Section 8. See Section 11 for additional information on health hazards. For waste disposal, see section 13.
------------------------------------	--

---

## SECTION 7: Handling and storage

---

### 7.1. Precautions for safe handling

<b>Usage precautions</b>	Avoid spilling. Always remove oil with soap and water or skin cleaning agent, never use organic solvents. Do not use oil-contaminated clothing or shoes, and do not put rags moistened with oil into pockets.
--------------------------	---

### 7.2. Conditions for safe storage, including any incompatibilities

<b>Storage precautions</b>	Store in tightly-closed, original container in a dry, cool and well-ventilated place.
<b>Storage class</b>	Miscellaneous hazardous material storage.

### 7.3. Specific end use(s)

<b>Specific end use(s)</b>	The identified uses for this product are detailed in Section 1.2.
----------------------------	---

## SECTION 8: Exposure Controls/personal protection

### 8.1. Control parameters

#### Occupational exposure limits

##### **Distillates (petroleum) solvent-dewaxed heavy paraffinic**

Long-term exposure limit (8-hour TWA): ACGIH 5 mg/m<sup>3</sup>  
 Short-term exposure limit (15-minute): ACGIH 10 mg/m<sup>3</sup>

##### **Distillates,hydrotreated heavy paraffinic**

Long-term exposure limit (8-hour TWA): ACGIH 5  
 Short-term exposure limit (15-minute): ACGIH 10 mg/m<sup>3</sup>

##### **Highly refined mineral oil (C15 - C50)**

Long-term exposure limit (8-hour TWA): ACGIH 5 ppm  
 Short-term exposure limit (15-minute): ACGIH 10 ppm

##### **Zinc bis[O-(6-methylheptyl)]bis[O-(sec-butyl)]bis(dithiophosphate)**

Short-term exposure limit (15-minute): 10 mg/m<sup>3</sup> mist

ACGIH = American Conference of Governmental Industrial Hygienists.

#### Bis(nonylphenyl)amine

<b>DNEL</b>	Industry - Dermal; Long term systemic effects: 0.62 mg/kg Industry - Inhalation; Long term systemic effects: 4.37 mg/m <sup>3</sup> Consumer - Dermal; Long term systemic effects: 0.31 mg/kg Consumer - Inhalation; Long term systemic effects: 1.09 mg/m <sup>3</sup> Consumer - Oral; Long term systemic effects: 0.31 mg/kg
<b>PNEC</b>	- Marine water; 0.01 mg/l - Sediment (Freshwater); 132000 mg/kg - Sediment (Marinewater); 13200 mg/kg - Soil; 263000 mg/kg - Fresh water; 0.1 mg/l

#### Phenol, dodecyl-,sulfurized, carbonates, calcium salts, overbased

<b>DNEL</b>	Industry - Dermal; Short term systemic effects: 80 mg/kg/day Industry - Inhalation; Short term systemic effects: 167 mg/m <sup>3</sup> Industry - Dermal; Long term systemic effects: 20.8 mg/kg/day Industry - Inhalation; Long term systemic effects: 70.52 mg/m <sup>3</sup> Consumer - Dermal; Short term systemic effects: 40 mg/kg/day Consumer - Oral; Short term systemic effects: 50 mg/m <sup>3</sup> Consumer - Oral; Long term systemic effects: 5 mg/kg/day Consumer - Dermal; Long term systemic effects: 10.42 mg/kg/day Consumer - Inhalation; Long term systemic effects: 52.6 mg/m
<b>PNEC</b>	- Fresh water; 0.1 mg/l - Marine water; 0.01 mg/l - Sediment (Freshwater); 132000 mg/kg - Sediment (Freshwater); 13200 mg/kg - Soil; 263000 mg/kg

#### Reaction mass of isomers of: C7-9-alkyl 3-(3,5-di-tert-butyl-4-hydroxyphenyl)propionate

<b>DNEL</b>	Industry - Dermal; Short term systemic effects: 20 mg/kg Industry - Dermal; Short term local effects: 1 mg/cm <sup>2</sup> Industry - Dermal; Long term systemic effects: 0.22 mg/kg Industry - Dermal; Long term local effects: 0.006 mg/cm <sup>2</sup>
<b>PNEC</b>	- Fresh water; 0.0043 mg/l - Marine water; 0.00043 mg/l - Sediment (Freshwater); 233 mg/kg - Sediment (Marinewater); 23.3 mg/kg - Soil; 189 mg/kg



## 8.2. Exposure controls

### Protective equipment



### Appropriate engineering controls

Provide adequate general and local exhaust ventilation. Observe any occupational exposure limits for the product or ingredients.

### Eye/face protection

Eyewear complying with an approved standard should be worn if a risk assessment indicates eye contact is possible. The following protection should be worn: Chemical splash goggles or face shield.

### Hand protection

The most suitable glove should be chosen in consultation with the glove supplier/manufacturer, who can provide information about the breakthrough time of the glove material.

### Other skin and body Protection

Use barrier creams to prevent skin contact.

### Hygiene measures

Use engineering controls to reduce air contamination to permissible exposure level. Wash promptly with soap and water if skin becomes contaminated.

### Respiratory protection

No specific recommendations. Respiratory protection must be used if the airborne contamination exceeds the recommended occupational exposure limit.

### Thermal hazards

Not anticipated under normal conditions of use. The product is combustible if heated excessively and an ignition source is applied.

### Environmental exposure Controls

Do not allow product to contaminate land.

## SECTION 9: Physical and Chemical Properties

### 9.1. Information on basic physical and chemical properties

Appearance	Liquid.
Colour	Pale Amber
Odour	Characteristic. Oil-like.
Odour threshold	Not known.
pH	Not applicable.
Melting point	-39°C Pour point
Initial boiling point and range	>320°C @ 101.3 kPa
Flash point	208°C PMCC (Pensky-Martens closed cup).
Evaporation rate	Not relevant.
Upper/lower flammability or explosive limits	Not known.
Other flammability	Product is not flammable but on excessive heating may become combustible.
Vapour pressure	<0.1 kPa @ 20°C
Vapour density	Not determined.
Relative density	0.870 @ 15.6°C
Solubility(ies)	Insoluble in water. Soluble in the following materials: Organic solvents.
Partition coefficient	Not determined. log Kow: > 7 The above figure is typical of mineral oil.
Auto-ignition temperature	No specific test data are available.

<b>Decomposition Temperature</b>	Not determined.
<b>Viscosity</b>	89.4 cSt @ 40°C
<b>Explosive properties</b>	Not considered to be explosive.
<b>Explosive under the influence of a flame</b>	Not considered to be explosive.
<b>Oxidising properties</b>	The mixture itself has not been tested but none of the ingredient substances meet the criteria for classification as oxidising.

**9.2. Other information**

Volatile organic compound The product is a complex mixture, the majority of which would not be classed as a VOC. However it cannot be discounted that trace or low levels of VOC's may be present.

---

**SECTION 10: Stability and reactivity**

**10.1. Reactivity**

Reactivity There are no known reactivity hazards associated with this product.

**10.2. Chemical stability**

Stability Stable at normal ambient temperatures and when used as recommended.

**10.3. Possibility of hazardous reactions**

**Possibility of hazardous reactions** Unlikely to occur under normal conditions of use. Unlikely to occur.

**10.4. Conditions to avoid**

**Conditions to avoid** Avoid heat, flames and other sources of ignition.

**10.5. Incompatible materials**

**Materials to avoid** Strong oxidising agents.

**10.6. Hazardous decomposition products**

**Hazardous decomposition Products** Oxides of carbon. Oxides of nitrogen.

---

**SECTION 11: Toxicological information**

**11.1. Information on toxicological effects**

**Acute toxicity – oral**  
**Notes (oral LD<sub>50</sub>)**

Not expected to be highly toxic based on information of ingredients. Based on available data the classification criteria are not met.

**Acute toxicity – dermal**  
**Notes (dermal LD<sub>50</sub>)**

Not expected to be highly toxic based on information of ingredients. Based on available data the classification criteria are not met.

**Acute toxicity – inhalation**  
**Notes (inhalation LC<sub>50</sub>)**

Not determined. The product is unlikely to present any significant inhalation hazard at ambient temperatures and under normal conditions of use.

**Serious eye damage/irritation**  
**Serious eye damage/irritation**

May cause mild, short lasting discomfort to eyes.

**Respiratory sensitisation**  
**Respiratory sensitisation**

No evidence to suggest the product will be a respiratory sensitiser. Repeated exposure to oil mists may cause respiratory damage.

**Skin sensitisation**  
**Skin sensitisation**

Not expected to be a skin sensitizer based on information on components.

**Carcinogenicity**  
**Carcinogenicity**

This product contains mineral oils which are considered to be severely refined and not considered to be carcinogenic under IARC. All of the oils in this product have been demonstrated to contain less than 3% extractables by the IP346 test

**Reproductive toxicity**  
**Reproductive toxicity - fertility**

No data available to suggest the product will cause reproductive toxicity.

**Specific target organ toxicity - single exposure**  
**STOT - single exposure**

Based on available data the classification criteria are not met.

**Specific target organ toxicity - repeated exposure**  
**STOT - repeated exposure**

Based on available data the classification criteria are not met.

**Aspiration hazard**  
**Aspiration hazard**

Kinematic viscosity > 20.5 mm<sup>2</sup>/s. The product viscosity is greater than the upper limit assigned for classification. The product contains mineral oil. If aspirated into the lungs e.g. through vomiting after ingestion admit to hospital immediately.

**General information**

This product has low toxicity. Only large quantities are likely to have adverse effects on human health.

**Inhalation**

Unlikely to be hazardous by inhalation because of the low vapour pressure of the product at ambient temperature.

**Ingestion**

No harmful effects expected from quantities likely to be ingested by accident.

**Skin contact**

Skin irritation should not occur when used as recommended. Repeated exposure may cause skin dryness or cracking.

**Eye contact**

May cause temporary eye irritation.

**Acute and chronic health Hazards**

Prolonged or repeated contact with used oil may cause serious skin diseases, such as dermatitis and skin cancer.

**SECTION 12: Ecological Information**

**Ecotoxicity**

Based on available data the classification criteria are not met. Not regarded as dangerous for the environment.

**12.1. Toxicity**

**Toxicity**

Based on available data the classification criteria are not met. Not considered toxic to fish.

**Acute toxicity – aquatic Invertebrates**

Based on available data the classification criteria are not met.

**12.2. Persistence and degradability**

**Persistence and degradability**

The product contains mineral oil which has limited biodegradability in CEC test methods but will biodegrade slowly in aerobic water and sediments and is considered ultimately biodegradable.

**Stability (hydrolysis)**

The product is based on highly refined mineral oils that are considered stable to hydrolysis.

**Biodegradation**

The product is not considered readily biodegradeable, albeit the major constituents are expected to ultimately biodegrade.

**Biological oxygen demand  
 Chemical oxygen demand**

Not determined.  
 Not determined.

**12.3. Bioaccumulative potential**

**Bioaccumulative potential  
 Partition coefficient**

Bioaccumulation is unlikely to be significant because of the low water-solubility of this product. Not determined. log Kow: > 7 The above figure is typical of mineral oil.

**12.4. Mobility in soil**

**Mobility**

The product is non-volatile. The product is insoluble in water and will spread on the water surface.

**Henry's law constant**

Not determined.

### **12.5. Results of PBT and vPvB assessment**

**Results of PBT and vPvB assessment** This product does not contain any substances classified as PBT or vPvB.

### **12.6. Other adverse effects**

**Other adverse effects** None known.

## **SECTION 13: Disposal considerations**

### **13.1. Waste treatment methods**

**General information** This material and its container must be disposed of as hazardous waste. Dispose of waste via a licensed waste disposal contractor.

**Disposal methods** Waste, residues, empty containers, discarded work clothes and contaminated cleaning materials should be collected in designated containers, labelled with their contents. Dispose of waste via a licensed waste disposal contractor.

**Waste class** European waste catalogue (EWC) number = 13 02 08\* (other engine, gear and lubricating oil)

## **SECTION 14: Transport information**

**General** The product is not covered by international regulations on the transport of dangerous goods (IMDG, IATA, ADR/RID).

### **14.1. UN number**

Not applicable.

### **14.2. UN proper shipping name**

Not applicable.

### **14.3. Transport hazard class(es)**

No transport warning sign required.

### **14.4. Packing group**

Not applicable.

### **14.5. Environmental hazards**

Environmentally hazardous substance/marine pollutant

### **14.6. Special precautions for user**

Not applicable.

### **14.7. Transport in bulk according to Annex II of MARPOL73/78 and the IBC Code**

**Transport in bulk according to Annex II of MARPOL 73/78 and the IBC Code** Not applicable.

## **SECTION 15: Regulatory information**

### **15.1. Safety, health and environmental regulations/legislation specific for the substance or mixture**

**National regulations** Health and Safety at Work etc. Act 1974 (as amended).  
The Chemicals (Hazard Information and Packaging for Supply) Regulations 2009 (SI 2009 No. 716).  
Control of Substances Hazardous to Health Regulations 2002 (as amended).  
The Carriage of Dangerous Goods and Use of Transportable Pressure Equipment Regulations 2009 (SI 2009 No. 1348) (as amended) ["CDG 2009"].

**EU legislation** Dangerous Preparations Directive 1999/45/EC.  
Dangerous Substances Directive 67/548/EEC.  
Regulation (EC) No 1907/2006 of the European Parliament and of the Council of 18 December 2006 concerning the Registration, Evaluation, Authorisation and Restriction of Chemicals (REACH) (as amended).  
Regulation (EC) No 1272/2008 of the European Parliament and of the Council of 16 December 2008 on classification, labelling and packaging of substances and mixtures (as amended).

**Guidance** Workplace Exposure Limits EH40.  
Safety Data Sheets for Substances and Preparations.

## **15.2. Chemical safety assessment**

No chemical safety assessment has been carried out.

### **Inventories**

#### **Canada - DSL/NDSL**

All the ingredients are listed or exempt.

#### **US - TSCA**

All the ingredients are listed or exempt.

#### **Australia - AICS**

All the ingredients are listed or exempt.

#### **Korea - KECI**

All the ingredients are listed or exempt.

#### **China - IECSC**

All the ingredients are listed or exempt.

#### **Philippines – PICCS**

All the ingredients are listed or exempt.

#### **New Zealand - NZIOC**

All the ingredients are listed or exempt.

---

## **SECTION 16: Other information**

---

<b>Revision comments</b>	NOTE: Lines within the margin indicate significant changes from the previous revision.
<b>Revision date</b>	11/11/2015
<b>Revision</b>	1
<b>SDS number</b>	21580
<b>Hazard statements in full</b>	H304 May be fatal if swallowed and enters airways.

## 2. Torq-Gard Supreme 15W-40

### SAFETY DATA SHEET Torq-Gard Supreme 15W-40

#### 1. IDENTIFICATION OF THE SUBSTANCE/PREPARATION AND COMPANY/UNDERTAKING

<b>Product Code</b>	901L0611
<b>Infosafe No.</b>	ACNUV GB/eng/C
<b>Issued Date</b>	25/10/2006
<b>Product Type/Use</b>	Engine oil.
<b>Supplier</b>	<b>Telephone Numbers</b>
	<b>Emergency Tel.</b>
Deere & company	+1 352 323 3500
European office	
Steubenstrasse 36-42	<b>Telephone/Fax Number</b>
68163 Mannheim	Tel: +49 621 829 01
GERMANY	

#### 2. COMPOSITION/INFORMATION ON INGREDIENTS

##### Preparation Description

Highly refined mineral oils and additives. The highly refined mineral oil contains <3% (w/w) DMSO-extract, according to IP346.

##### Dangerous Components / Constituents

Exposure limits apply to the following components: Highly refined mineral oil.

Name	CAS	EINECS	Proportion	Hazard	R Phrase
Zinc alkyl dithiophosphate	68649-42-3	272-028-3	1-2.49 %	Xi, N	R38, R41, R51/53

##### Other Information

See Section 16 'Other Information' for full text of each relevant Risk Phrase.

#### 3. HAZARDS IDENTIFICATION

<b>EC Classification</b>	Not classified as Dangerous under EC criteria.
--------------------------	--

##### Human Health Hazards

No specific hazards under normal use conditions. Prolonged or repeated exposure may give rise to dermatitis. Used oil may contain harmful impurities.

##### Safety Hazards

Not classified as flammable, but will burn.

##### Environmental Hazards

Not classified as dangerous for the environment.

#### 4. FIRST AID MEASURES

##### Symptoms and Effects

Not expected to give rise to an acute hazard under normal conditions of use.

##### Inhalation

In the unlikely event of dizziness or nausea, remove casualty to fresh air. If symptoms persist, obtain medical attention.

##### Skin

Remove contaminated clothing and wash affected skin with soap and water. If persistent irritation occurs, obtain medical attention. When using high pressure equipment, injection of product under the skin can occur. If high pressure injuries occur, the casualty should be sent immediately to a hospital. Do not wait for symptoms to develop.

**Eye**

Flush eye with copious quantities of water. If persistent irritation occurs, obtain medical attention.

**Ingestion**

Wash out mouth with water and obtain medical attention. Do not induce vomiting.

**Advice to Doctor**

Treat symptomatically. Aspiration into the lungs may result in chemical pneumonitis. Dermatitis may result from prolonged or repeated exposure. High pressure injection injuries require prompt surgical intervention and possibly steroid therapy, to minimise tissue damage and loss of function.

Because entry wounds are small and do not reflect the seriousness of the underlying damage, surgical exploration to determine the extent of involvement may be necessary. Local anaesthetics or hot soaks should be avoided because they can contribute to swelling, vasospasm and ischaemia. Prompt surgical decompression, debridement and evacuation of foreign material should be performed under general anaesthetics, and wide exploration is essential.

There may be a risk to health where low viscosity products are aspirated into the lungs following vomiting, although this is uncommon in adults. Such aspiration would cause intense local irritation and chemical pneumonitis. Children, and those in whom consciousness is impaired, will be more at risk. Emesis of lubricants is not usually necessary, unless a large amount has been ingested, or some other compound has been dissolved in the product. If this is indicated, for example, when there is rapid onset of central nervous system depression from large ingested volume - gastric lavage under controlled hospital conditions, with full protection of the airway is required. Supportive care may include oxygen, arterial blood gas monitoring, respiratory support, and, if aspiration has occurred, treatment with corticosteroids and antibiotics. Seizures should be controlled with Diazepam, or appropriate equivalent drug.

---

**5. FIRE FIGHTING MEASURES**

---

**Specific Hazards**

Combustion is likely to give rise to a complex mixture of airborne solid and liquid particulates and gases, including carbon monoxide and unidentified organic and inorganic compounds.

**Extinguishing Media**

Foam and dry chemical powder. Carbon dioxide, sand or earth may be used for small fires only.

**Unsuitable Extinguishing Media**

Water in jet. Use of halon extinguishers should be avoided for environmental reasons.

**Protective Equipment**

Proper protective equipment including breathing apparatus must be worn when approaching a fire in a confined space.

---

**6. ACCIDENTAL RELEASE MEASURES**

---

**Personal Precautions**

Avoid contact with skin and eyes. Wear PVC, Neoprene or nitrile rubber gloves. Wear rubber knee length safety boots and PVC Jacket and Trousers. Wear safety glasses or full face shield if splashes are likely to occur.

**Environmental Precautions**

Prevent from spreading or entering into drains, ditches or rivers by using sand, earth, or other appropriate barriers. Inform local authorities if this cannot be prevented.

**Clean-up Methods - Small Spillages**

Absorb liquid with sand or earth. Sweep up and remove to a suitable, clearly marked container for disposal in accordance with local regulations.

### Clean-up Methods - Large Spillages

Prevent from spreading by making a barrier with sand, earth or other containment material. Reclaim liquid directly or in an absorbent. Dispose of as for small spills.

## 7. HANDLING AND STORAGE

### Handling

Use local exhaust ventilation if there is risk of inhalation of vapours, mists or aerosols. Avoid prolonged or repeated contact with skin. When handling product in drums, safety footwear should be worn and proper handling equipment should be used. Prevent spillages. Cloth, paper and other materials that are used to absorb spills present a fire hazard. Avoid their accumulation by disposing of them safely and immediately. In addition to any specific recommendations given for controls of risks to health, safety and the environment, an assessment of risks must be made to help determine controls appropriate to local circumstances. Exposure to this product should be reduced as low as reasonably practicable. Reference should be made to the Health and Safety Executive's publication 'COSHH Essentials'.

### Storage

Keep in a cool, dry, well-ventilated place. Use properly labelled and closeable containers. Avoid direct sunlight, heat sources, and strong oxidizing agents. The storage of this product maybe subject to the Control of Pollution (Oil Storage) (England) Regulations. Further guidance maybe obtained from the local environmental agency office.

### Storage Temperatures

0°C Minimum. 50°C Maximum.

### Recommended Materials

For containers or container linings, use mild steel or high density polyethylene.

### Unsuitable Materials

For containers or container linings, avoid PVC.

### Other Information

Polyethylene containers should not be exposed to high temperatures because of possible risk of distortion.

## 8. EXPOSURE CONTROLS, PERSONAL PROTECTION

### Exposure Limits

Substance	Regulations	Exposure Duration	Exposure Limit	Units	Notes
Oil mist, mineral	EH 40 2005	TWA	5	mg/m <sup>3</sup>	
	EH 40 2005	STEL	10	mg/m <sup>3</sup>	

EH 40 2005 EH 40 2005 Health and Safety Executive. EH40; Workplace Exposure Limits

### Exposure Controls

The use of personal protective equipment is only one aspect of an integrated approach to the Control Of Substances Hazardous to Health.

The management of Health and Safety at Work Regulations 1992 require employers to identify and evaluate the risks to health and to implement appropriate measures to eliminate or minimise those risks. The choice of personal protective equipment is highly dependent upon local conditions, e.g. exposure to other chemical substances and micro-organisms, thermal hazards (protection from extremes of cold and heat), electrical hazards, mechanical hazards and appropriate degree of manual dexterity required to undertake an activity. Whilst the content of this section may inform the choice of personal protective equipment used, the limitations of any information which can be provided must be fully understood, e.g. personal protective equipment chosen to protect employees from occasional splashes maybe entirely inadequate for activities involving partial or complete immersion. If the levels of oil mist or vapour in air are likely to exceed the occupational exposure standards then consideration should be given to the use of local exhaust ventilation to reduce personal exposure.

The choice of personal protective equipment should only be undertaken in the light of a full risk assessment by a suitably qualified competent person ( e.g. a professionally qualified occupational hygienist).



Effective protection is only achieved by correctly fitting and well maintained equipment and employers should ensure that appropriate training is given. All personal protective equipment should be regularly inspected and replaced if defective. Reference should be made to HSE's publication Methods for the Determination of Hazardous Substances (MDHS) 84 - Measurement of oil mist from mineral oil-based metalworking fluids. Measurement of an employee's exposure to oil vapour maybe supplemented through the use of stain tubes. In the first instance, further guidance maybe obtained through HSE's publication 'COSHH - a brief guide to the regulations' (INDG 136(rev1)).

### Respiratory Protection

At standard temperature and pressure, the Occupational Exposure Standard for oil vapour is unlikely to be exceeded. Care should be taken to keep exposures below applicable occupational exposure limits. If this cannot be achieved, use of a respirator fitted with an organic vapour cartridge combined with a particulate pre-filter should be considered. Half masks (EN 149) or valved half masks (EN 405) in combination with type A2 (EN 141) and P2/3 (EN 143) pre-filters maybe considered.

### Hand Protection

Chemical protective gloves are made from a wide range of materials, but there is no single glove material ( or combination of materials) which gives unlimited resistance to any individual or combination of substances or preparations. The extent of the breakthrough time will be affected by a combination of factors which include permeation, penetration, degradation, use pattern ( full immersion, occasional contacts) and how the glove is stored when not in use.

Theoretical maximum levels of protection are seldom achieved in practice and the actual level of protection can be difficult to assess. Effective breakthrough time should be used with care and a margin of safety should be applied. HSE guidance on protective gloves recommends a 75% safety factor to be applied to any figures obtained in a laboratory test. Nitrile gloves may offer relatively long breakthrough times and slow permeation rates. Test data, e.g breakthrough data obtained through test standard EN374-3:1994 are available from reputable equipment suppliers.

Personal hygiene is a key element of effective hand care. Gloves must only be worn on clean hands. After using gloves, hands should be washed and dried thoroughly. A non perfumed moisturiser should be applied.

### Eye Protection

Goggles conforming to a minimum standard of EN 166 345B should be considered if there is a possibility of eye contact with the product through splashing. Higher rated eye protection must be considered for highly hazardous operations or work areas. For example, employees involved in metalworking operations such as chipping, grinding or cutting may require additional protection to avert injury from fast moving particles or broken tools.

### Body Protection

Minimise all forms of skin contact. Overalls and shoes with oil resistant soles should be worn. Launder overalls and undergarments regularly.

### Environmental Exposure Controls

Minimise release to the environment. An environmental assessment must be made to ensure compliance with local environmental legislation.

---

## 9. PHYSICAL AND CHEMICAL PROPERTIES

---

<b>Colour</b>	Amber.
<b>Physical State</b>	Liquid at ambient temperature.
<b>Odour</b>	Characteristic mineral oil.
<b>pH Value</b>	Data not available.
<b>Vapour Pressure</b>	<0.5 Pa at 20°C (based on mineral oil).
<b>Initial Boiling Point</b>	Expected to be above 280°C.
<b>Solubility in Water</b>	Negligible.
<b>Density</b>	886 kg/m <sup>3</sup> at 15°C.
<b>Flash Point</b>	205°C. (PMCC).
<b>Flammable Limits - Upper</b>	10% V/V (typical) (based on mineral oil).
<b>Flammable Limits - Lower</b>	1% V/V (typical) (based on mineral oil).
<b>Auto-Ignition Temperature</b>	Expected to be above 320°C.
<b>Kinematic Viscosity</b>	105.1 mm <sup>2</sup> /s at 40°C.
<b>Evaporation Rate</b>	Data not available.
<b>Vapour Density (Air=1)</b>	Greater than 1.

Partition co-efficient, n-octanol/water  
Pour Point

Log Pow expected to be greater than 6.  
-39°C.

---

## 10. STABILITY AND REACTIVITY

---

### Stability

Stable.

### Conditions to Avoid

Extremes of temperature and direct sunlight.

### Materials to Avoid

Strong oxidizing agents.

### Hazardous Decomposition Products

Hazardous decomposition products are not expected to form during normal storage.

---

## 11. TOXICOLOGICAL INFORMATION

---

### Basis for Assessment

Toxicological data have not been determined specifically for this product. Information given is based on a knowledge of the components and the toxicology of similar products.

### Acute Toxicity - Oral

LD50 expected to be > 2000 mg/kg.

### Acute Toxicity - Dermal

LD50 expected to be > 2000 mg/kg.

### Acute Toxicity - Inhalation

Not considered to be an inhalation hazard under normal conditions of use.

### Eye Irritation

Expected to be slightly irritating.

### Skin Irritation

Expected to be slightly irritating.

### Respiratory Irritation

If mists are inhaled, slight irritation of the respiratory tract may occur.

### Skin Sensitisation

Not expected to be a skin sensitizer.

### Carcinogenicity

Product is based on mineral oils of types shown to be non-carcinogenic in animal skin-painting studies. Other components are not known to be associated with carcinogenic effects.

### Mutagenicity

Not considered to be a mutagenic hazard.

### Reproductive Toxicity

Not considered to be toxic to reproduction.

### Other Information

Prolonged and/or repeated contact with this product can result in defatting of the skin, particularly at elevated temperatures. This can lead to irritation and possibly dermatitis, especially under conditions of poor personal hygiene. Skin contact should be minimised. High pressure injection of product into the skin may lead to local

necrosis if the product is not surgically removed. Used oils may contain harmful impurities that have accumulated during use. The concentration of such impurities will depend on use and they may present risks to health and the environment on disposal. ALL used oil should be handled with caution and skin contact avoided as far as possible. It is prudent to assume that prolonged or repeated exposure to used engine oils may cause skin cancer.

---

## 12. ECOLOGICAL INFORMATION

---

### **Basis for Assessment**

Ecotoxicological data have not been determined specifically for this product. Information given is based on a knowledge of the components and the ecotoxicology of similar products.

### **Mobility**

Liquid under most environmental conditions. Floats on water. If it enters soil, it will adsorb to soil particles and will not be mobile.

### **Persistence / Degradability**

Not expected to be readily biodegradable. Major constituents are expected to be inherently biodegradable, but the product contains components that may persist in the environment.

### **Bioaccumulation**

Contains components with the potential to bioaccumulate.

### **Ecotoxicity**

Poorly soluble mixture. May cause physical fouling of aquatic organisms. Product is expected to be practically non-toxic to aquatic organisms, LL/EL50 >100 mg/l. (LL/EL50 expressed as the nominal amount of product required to prepare aqueous test extract). Mineral oil is not expected to cause any chronic effects to aquatic organisms at concentrations less than 1 mg/l.

### **Other Adverse Effects**

Not expected to have ozone depletion potential, photochemical ozone creation potential or global warming potential.

Product is a mixture of non-volatile components, which are not expected to be released to air in any significant quantities.

---

## 13. DISPOSAL CONSIDERATIONS

---

### **Waste Disposal**

Recycle or dispose of in accordance with prevailing regulations, by a recognised collector or contractor. The competence of the contractor to deal satisfactorily with this type of product should be established beforehand. Do not pollute the soil, water or environment with the waste product.

### **Product Disposal**

As for waste disposal.

### **Container Disposal**

Recycle or dispose of in accordance with the legislation in force with a recognised collector or contractor.

---

## 14. TRANSPORT INFORMATION

---

### **Transport Information**

Not dangerous for transport under ADR/RID, IMO and IATA/ICAO regulations.

### **ADR/RID Class**

None Allocated

### **ADR/RID Packing Group**

None Allocated

### **IMDG Hazard Class**

None Allocated

**IMDG Packing Group**

None Allocated

**IATA Hazard Class**

None Allocated

**IATA Packing Group**

None Allocated

**15. REGULATORY INFORMATION**

EC Symbols	None.
EC Risk Phrase	Not classified.
EC Safety Phrase	Not classified.
EINECS	All components listed or polymer exempt.
TSCA (USA)	All components in compliance.

**National Legislation**

Environmental Protection Act 1990 (as amended).  
 Health and Safety at Work Act 1974  
 Consumers Protection Act 1987  
 Control of Pollution Act 1974  
 Environmental Act 1995  
 Factories Act 1961  
 Carriage of Dangerous Goods by Road and Rail (Classification, Packaging and Labelling) Regulations  
 Chemicals (Hazard Information and Packaging for Supply) Regulations 2002.  
 Control of Substances Hazardous to Health Regulations 1994 (as amended).  
 Road Traffic (Carriage of Dangerous Substances in Packages) Regulations  
 Merchant Shipping (Dangerous Goods and Marine Pollutants) Regulations  
 Road Traffic (Carriage of Dangerous Substances in Road Tankers in Tank Containers) Regulations  
 Road Traffic (Training of Drivers of Vehicles Carrying Dangerous Goods) Regulations  
 Reporting of Injuries, Diseases and Dangerous Occurrences Regulations  
 Health and Safety (First Aid) Regulations 1981  
 Personal Protective Equipment (EC Directive) Regulations 1992  
 Personal Protective Equipment at Work Regulations 1992

**Packaging & Labelling**

Safety data sheet available for professional user on request.

**16. OTHER INFORMATION**

**Revisions Highlighted**

To assist harmonisation of sds authoring practices, a version number has been introduced.

**References**

**GUIDANCE NOTES**

UK Chemicals Regulatory Atlas, An Overview of how to guide your chemical through to regulatory compliance (DTI).  
 HSG71 The storage of packaged dangerous substances.  
 EH/40 Occupational Exposure Limits.  
 EH/58 The Carcinogenicity of Mineral Oils.  
 MS24 Health surveillance of occupational skin disease.  
 HSG 53 The selection, use and maintenance of respiratory protective equipment: A practical guide.  
 HSG 206 Cost and effectiveness of chemical protective gloves for the workplace: Guidance for employers and health and safety specialists.  
 L74 First Aid at work: Approved Code of Practice and Guidance.  
 HSG 136 Workplace transport safety : guidance for employers.  
 INDG234 (rev) Are you Involved in the Carriage of Dangerous Goods by Road or Rail

#### OTHER LITERATURE

Concawe Report 3/82 Precautionary Advice on the Handling of Used Engine Oils  
Concawe Report 86/69 Health Aspects of Worker Exposure to Oil Mists  
Concawe Report 01/97 Petroleum Products - First Aid Emergency and Medical Advice  
Concawe Report 01/53 Classification and labelling of petroleum substances according to the EU dangerous substances directive ( Concawe recommendations August 2001)  
Concawe Report 01/54 environmental classification of petroleum substances summary data and rationale  
Concawe Report 5/02 amended safety data sheet directive ( 2001/58/EC)  
Department of the Environment - Waste Management - The Duty of Care - A Code of Practice  
Concawe, Boulevard du souverain 165 B - 1160 Brussels, Belgium  
[www.concawe.be](http://www.concawe.be)

#### Restrictions

This product must not be used in applications other than recommended without first seeking the advice of the Barrus technical department.

#### List of R Phrases in Section 2

R38 Irritating to skin.  
R41 Risk of serious damage to eyes.  
R51/53 Toxic to aquatic organisms, may cause long-term adverse effects in the aquatic environment.

#### Further Information

This information is based on our current knowledge and is intended to describe the product for the purposes of health, safety and environmental requirements only. It does not constitute a guarantee for any specific property of the product.

**SECTION 16 – Shire Service Record Card**



# SERVICE RECORD CARD

<b>Model:</b> ..... <b>Engine No:</b> .....	
Carried out by E.P.Barrus <b>Print Name:</b> <div style="font-size: 2em; opacity: 0.5; text-align: center;">PDI</div> <b>Actual Hours:</b> <b>Signed:</b>	<b>Boat Builder Stamp:</b> Commission of Boat and Hand Over to Customer. (Refer to the Installation Check List Page in this Manual). <b>Date:</b> <b>Signed:</b>
<b>Dealer Stamp:</b> <b>Actual Hours:</b> <span style="font-size: 2em; opacity: 0.5;">1st</span> <b>Signed:</b>	<b>Dealer Stamp:</b> <b>Actual Hours:</b> <span style="font-size: 2em; opacity: 0.5;">2nd</span> <b>Signed:</b>
<b>Dealer Stamp:</b> <b>Actual Hours:</b> <span style="font-size: 2em; opacity: 0.5;">3rd</span> <b>Signed:</b>	<b>Dealer Stamp:</b> <b>Actual Hours:</b> <span style="font-size: 2em; opacity: 0.5;">4th</span> <b>Signed:</b>
<b>Dealer Stamp:</b> <b>Actual Hours:</b> <span style="font-size: 2em; opacity: 0.5;">5th</span> <b>Signed:</b>	<b>Dealer Stamp:</b> <b>Actual Hours:</b> <span style="font-size: 2em; opacity: 0.5;">6th</span> <b>Signed:</b>

**Please refer to Owner’s Manual for service intervals**